

Koyo®

JTEKT
Koyo | TOYODA































Ball & Roller Bearings



JTEKT

JTEKT CORPORATION

CAT. NO. B2001E-7

<p>1 Structures and types A 1 4 Selection of arrangement A 20 7 Tolerances A 58 10 Internal clearance A 99 13 Materials A 130 16 Failures A 152</p> <p>2 Outline of selection A 14 5 Selection of dimensions A 24 8 Limiting speed A 84 11 Preload A 112 14 Shaft and housing design A 133</p> <p>3 Selection of type A 16 6 Boundary dimensions and bearing numbers A 52 9 Fits A 86 12 Lubrication A 117 15 Handling A 141</p>		Bearing specification tables	Technical section	
<p> Open type ... B 8 (67, 68, 69, 160, 60) (62, 63, 64)</p> <p> Shielded/sealed type ... B 20 (Z, RU) (RD, RS)</p> <p> Locating snap ring type ... B 32 (N) (NR)</p> <p> Extra-small & miniature ... B 40 (flanged type ... B 46)</p> <p> Double-row B 52 [42, 43]</p>				Deep groove ball bearings
<p> Single-row ... B 62 (79, 70, 72, 73, 74)</p> <p> Matched pair ... B 90 (DB, DF) (DT)</p> <p> Double-row ... B 118 (32, 33, 52, 53) (52...2RS, 53...2RS)</p>				Angular contact ball bearings
<p> Open type ... B 126 (12, 22) (13, 23)</p> <p> Sealed type ... B 132 (22...2RS) (23...2RS)</p> <p> Extended inner ring type ... B 134 [112, 113]</p> <p> Adapter assemblies ... B 136</p>				Self-aligning ball bearings
<p> NU</p> <p> NJ</p> <p> NUP</p> <p> N</p> <p> NF</p> <p>Single-row ... B 142 (NU10, NU2, NU22, NU32) (NU3, NU23, NU33, NU4)</p> <p> Thrust collars ... B 168 [HJ]</p> <p> Double-row ... B 178 (NN30) (NNU49)</p> <p>NN NNU</p>				Cylindrical roller bearings
<p> Metric series ... B 194 Inch series B 224 (329, 320, 330, 331, 302, 322) (332, 303, 303D, 313, 323, IS0)</p> <p> TDO type B 268 (462, 463, 46T302, 46T322) (46T303, 46T303D, 46T323)</p> <p> TDI type B 284 [452, 453]</p>				Tapered roller bearings
<p> R, RR</p> <p> RZ</p> <p> RHA</p> <p>... B 294 (239, 230, 240, 231, 241) (222, 232, 213, 223)</p> <p> Adapter assemblies ... B 318</p> <p> Withdrawal sleeves ... B 326</p>				Spherical roller bearings
<p> Single direction ... B 338 (511, 512, 513, 514) (532, 533, 534) (532U, 533U, 534U)</p> <p> Double direction ... B 348 (522, 523, 524) (542, 543, 544) (542U, 543U, 544U)</p> <p> ... B 356 [292, 293, 294]</p>				Thrust ball, Spherical thrust roller bearings
<p>Needle roller and cage ass'y Metric ... B 380 Inch ... B 408</p> <p>Drawn cup type Metric ... B 414 Inch ... B 424</p> <p>Heavy-duty type Metric ... B 432 Inch ... B 440</p> <p>Thrust needle roller Metric ... B 444 Inch ... B 452</p> <p>Thrust cylindrical roller ... B 448</p> <p>Combined ... B 460, B 462 (Ball thrust series) (Cylindrical roller thrust series)</p> <p>Inner ring ... B 466</p> <p>(Miniature one-way clutches) ... B 482</p>				Needle roller bearings
<p>[Products Introduction]</p> <ul style="list-style-type: none"> Ball bearing units B 486 				Ball bearing units
<ul style="list-style-type: none"> K-series super thin section ball bearings C 1 Bearings for railway rolling stock axle journals ... C 21 Linear ball bearings C 31 Accessories C 45 <p>[Products Introduction]</p> <ul style="list-style-type: none"> EXSEV & Ceramic bearing series C 57 Bearings for machine tool spindles (for support of axial loading) C 59 		Special purpose bearings		
<ul style="list-style-type: none"> Introduction of pamphlets and catalogs D 1 Products introduction of JTEKT D 13 (Bearings, Automotive Components, Sensors, Machine tools, Mechatronics) Products introduction in Japan Group Companies D 19 		Introduction of products, pamphlets and catalogs		
<ul style="list-style-type: none"> Supplementary tables E 1 – E 28 		Supplementary tables		
<ul style="list-style-type: none"> Index F 1 – F 18 		Index		

Koyo[®]

**BALL & ROLLER
BEARINGS**

Koyo

Publication of Rolling Bearing Catalog

Today's technology-based society, in order to utilize the earth's limited resources effectively and protect the environment, must strive to develop new technologies and alternate energy sources, and in that connection it continues to pursue new targets in various fields. To achieve such targets, technically advanced and highly functional rolling bearings with significantly greater compactness, lighter weight, longer life and lower friction as well as higher reliability during use in special environments are sought.

This new-edition catalog is based on the results of wide-ranging technical studies and extensive R&D efforts and will enable the reader to select the optimal bearing for each application.

JTEKT is confident that you will find this new catalog useful in the selection and use of rolling bearings. JTEKT is grateful for your patronage and look forward to continuing to serve you in the future.

★The contents of this catalog are subject to change without prior notice. Every possible effort has been made to ensure that the data herein is correct; however, JTEKT cannot assume responsibility for any errors or omissions.

Reproduction of this catalog without written consent is strictly prohibited

Contents

Technical section

1	Rolling bearing structures and types	
1-1	Structure	A 1
1-2	Type	A 1
2	Outline of bearing selection	A 14
3	Selection of bearing type	A 16
4	Selection of bearing arrangement	A 20
5	Selection of bearing dimensions	
5-1	Bearing service life	A 24
5-2	Calculation of service life	A 24
5-3	Calculation of loads	A 32
5-4	Dynamic equivalent load	A 38
5-5	Basic static load rating and static equivalent load.....	A 42
5-6	Allowable axial load for cylindrical roller bearings.....	A 44
5-7	Applied calculation examples...A	46
6	Boundary dimensions and bearing numbers	
6-1	Boundary dimensions.....	A 52
6-2	Dimensions of snap ring grooves and locating snap rings	A 53
6-3	Bearing number.....	A 54
7	Bearing tolerances	
7-1	Tolerances and tolerance classes for bearings	A 58
7-2	Tolerance measuring method...A	80
8	Limiting speed	
8-1	Correction of limiting speed.....	A 84
8-2	Limiting speed for sealed ball bearings...A	85
8-3	Considerations for high speed...A	85
8-4	Frictional coefficient (refer.).....	A 85

9	Bearing fits	
9-1	Purpose of fit	A 86
9-2	Tolerance and fit for shaft & housing	A 86
9-3	Fit selection	A 87
9-4	Recommended fits	A 90
10	Bearing internal clearance	
10-1	Selection of internal clearance	A 99
10-2	Operating clearance	A 100
11	Preload	
11-1	Purpose of preload	A 112
11-2	Method of preloading.....	A 112
11-3	Preload and rigidity.....	A 113
11-4	Amount of preload	A 114
12	Bearing lubrication	
12-1	Purpose and method of lubrication	A 117
12-2	Lubricant.....	A 124
13	Bearing materials	
13-1	Bearing rings and rolling elements materials.....	A 130
13-2	Materials used for cages	A 132
14	Shaft and housing design	
14-1	Accuracy and roughness of shafts and housings	A 133
14-2	Mounting dimensions	A 134
14-3	Shaft design	A 136
14-4	Sealing devices	A 137

15	Handling of bearings	
15-1	General instructions	A 141
15-2	Storage of bearings	A 141
15-3	Bearing mounting	A 141
15-4	Test run	A 146
15-5	Bearing dismantling.....	A 148
15-6	Maintenance and inspection of bearings.....	A 150
15-7	Methods of analyzing bearing failures.....	A 151
16	Examples of bearing failures	A 152

Specification tables Contents B 2

[Standard bearings]

• Deep groove ball bearings.....	B 4
• Angular contact ball bearings	B 54
• Self-aligning ball bearings.....	B 124
• Cylindrical roller bearings	B 138
• Tapered roller bearings.....	B 184
• Spherical roller bearings	B 290
• Thrust ball bearings	B 336
• Spherical thrust roller bearings	B 354
• Needle roller bearings.....	B 362
• Ball bearing units	B 486

[Special purpose bearings]

• K-series super thin section ball bearings	C 1
• Bearings for railway rolling stock axle journals	C 21
• Linear ball bearings	C 31
• Locknuts, lockwashers & lock plates	C 45
• EXSEV & Ceramic bearing series	C 57
• Bearings for machine tool spindles (for support of axial loading).....	C 59
• Precision ball screw support bearings and bearing units	C 61
• Full complement type cylindrical roller bearings for crane sheaves	C 63
• Rolling mill roll neck bearings	C 65

[Introduction of products, pamphlets and catalogs]

• Introduction of pamphlets and catalogs	D 1
• Products introduction of JTEKT	D 13
• Products introduction in Japan Group Companies.....	D 19

Supplementary tables

1	Boundary dimensions of radial bearings	E 1
2	Boundary dimensions of tapered roller bearings	E 5
3	Boundary dimensions of single direction thrust bearings.....	E 7
4	Boundary dimensions of double direction thrust ball bearings.....	E 9
5	Dimension of snap ring grooves and locating snap rings	E 11
6	Shaft tolerances	E 15
7	Housing bore tolerances	E 17
8	Numerical values for standard tolerance grades IT	E 19
9	Greek alphabet list	E 20
10	Prefixes used with SI units	E 20
11	SI units and conversion factors	E 21
12	Inch/millimeter conversion	E 25
13	Steel hardness conversion	E 26
14	Surface roughness comparison.....	E 27
15	Viscosity conversion.....	E 28

Index

Bearing No. index	F 1
Term index	F 16

1. Rolling bearing structures and types

1-1 Structure

Rolling bearings (bearings hereinafter) normally comprise bearing rings, rolling elements and a cage. (see Fig. 1-1)

Rolling elements are arranged between inner and outer rings with a cage, which retains the rolling elements in correct relative position, so they do not touch one another. With this structure, a smooth rolling motion is realized during operation.

Bearings are classified as follows, by the number of rows of rolling elements : single-row, double-row, or multi-row (triple- or four-row) bearings.

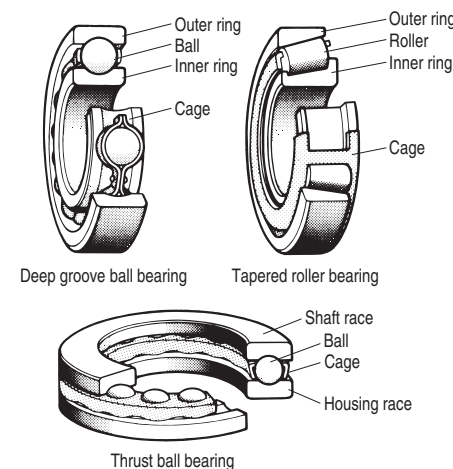

Note) In thrust bearings inner and outer rings are also called "shaft race" and "housing race" respectively. The race indicates the washer specified in JIS.

Fig. 1-1 Bearing structure

1) Bearing rings

The path of the rolling elements is called the raceway; and, the section of the bearing rings where the elements roll is called the raceway surface. In the case of ball bearings, since grooves are provided for the balls, they are also referred to as raceway grooves.

The inner ring is normally engaged with a shaft; and, the outer ring with a housing.

2) Rolling element

Rolling elements may be either balls or rollers. Many types of bearings with various shapes of rollers are available.

- Ball
- Cylindrical roller ($L_w \leq 3 D_w$)*
- ▬ Long cylindrical roller ($3 D_w \leq L_w \leq 10 D_w, D_w > 6 \text{ mm}$)*
- ▬ Needle roller ($3 D_w \leq L_w \leq 10 D_w, D_w \leq 6 \text{ mm}$)*
- ▭ Tapered roller (tapered trapezoid)
- ▭ Convex roller (barrel shape)

$$* \begin{cases} L_w : \text{roller length (mm)} \\ D_w : \text{roller diameter (mm)} \end{cases}$$

3) Cage

The cage guides the rolling elements along the bearing rings, retaining the rolling elements in correct relative position. There are various types of cages including pressed, machined, molded, and pin type cages.

Due to lower friction resistance than that found in full complement roller and ball bearings, bearings with a cage are more suitable for use under high speed rotation.

1-2 Type

The contact angle (α) is the angle formed by the direction of the load applied to the bearing rings and rolling elements, and a plan perpendicular to the shaft center, when the bearing is loaded.

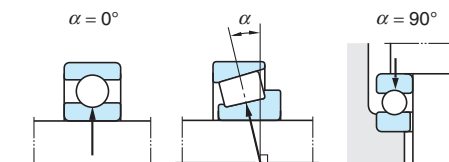

Bearings are classified into two types in accordance with the contact angle (α).

- Radial bearings ($0^\circ \leq \alpha \leq 45^\circ$)
... designed to accommodate mainly radial load.
- Thrust bearings ($45^\circ < \alpha \leq 90^\circ$)
... designed to accommodate mainly axial load.

Rolling bearings are classified in Fig. 1-2, and characteristics of each bearing type are described in Tables 1-1 to 1-13.

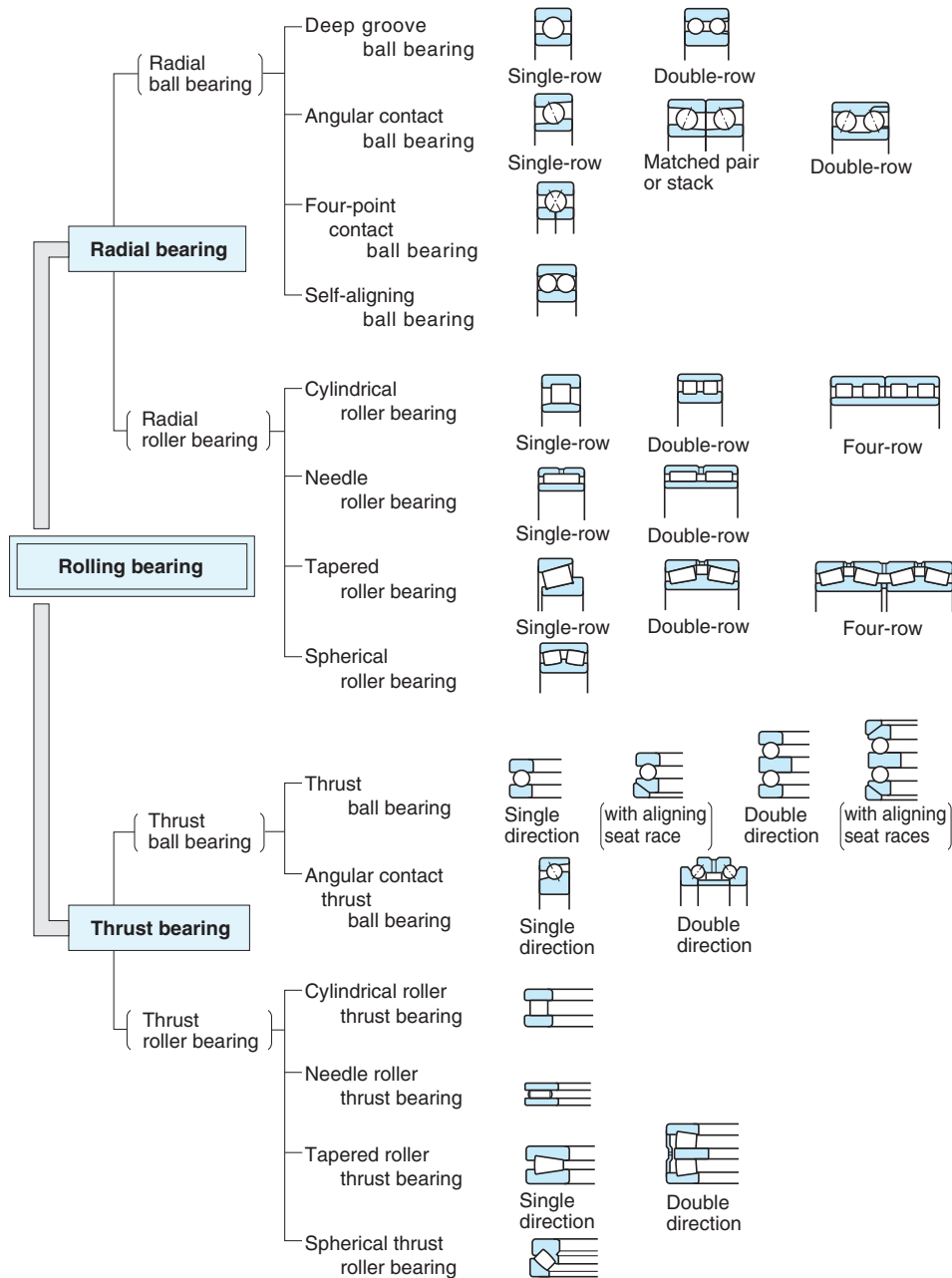
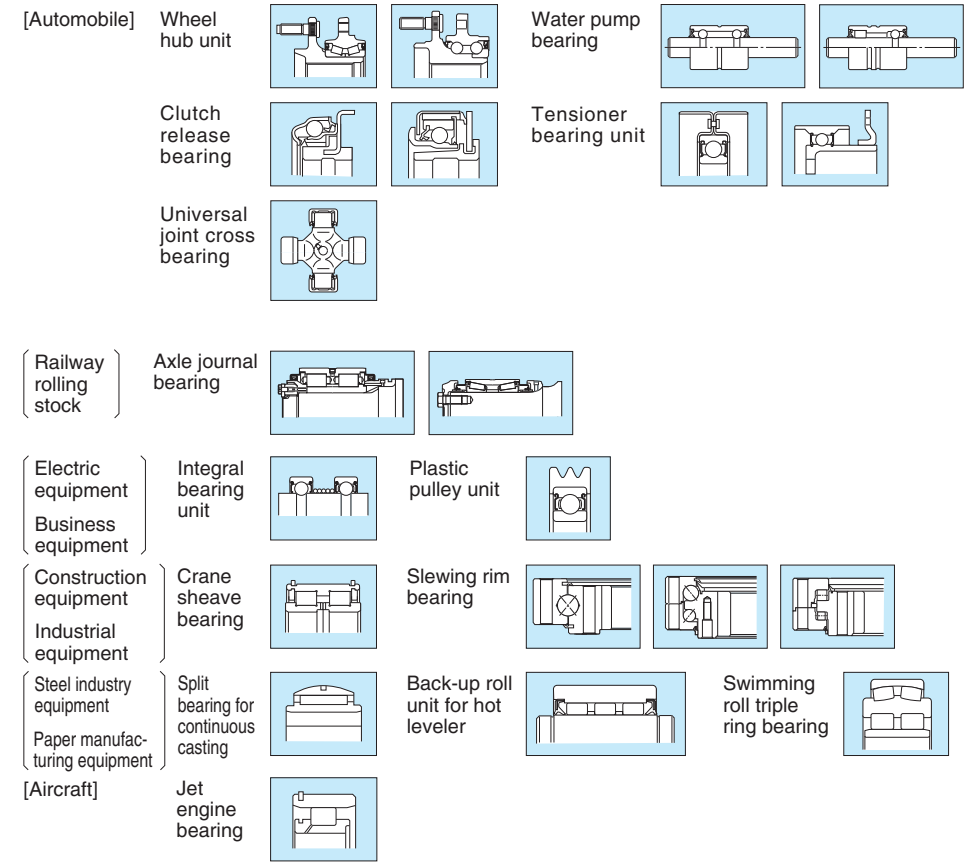

Fig. 1-2(1) Rolling bearings

Bearings classified by use



Others

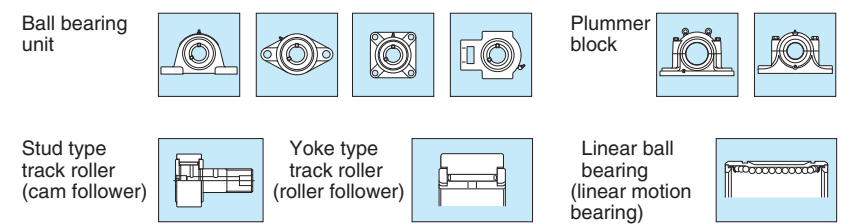

Fig. 1-2(2) Rolling bearings

Table 1-1 Deep groove ball bearings

Single-row							Double-row	
Open type	Shielded type	Non-contact sealed type	Contact sealed type		Extremely light contact sealed type	With locating snap ring	Flanged type	
	ZZ	2RU	2RS	2RK	2RD	NR	(Suitable for extra-small or miniature bearing)	
680, 690, 6700, 6800, 6900, 16000	600, 620, 630, (ML)	---Extra-small, miniature bearing					4200	4300

- The most popular types among rolling bearings, widely used in a variety of industries.
- Radial load and axial load in both directions can be accommodated.
- Suitable for operation at high speed, with low noise and low vibration.
- Sealed bearings employing steel shields or rubber seals are filled with the appropriate volume of grease when manufactured.
- Bearings with a flange or locating snap ring attached on the outer ring are easily mounted in housings for simple positioning of housing location.

[Recommended cages] Pressed cage (ribbon type, snap type ... single-row, S type ... double-row), copper alloy or phenolic resin machined cage, synthetic resin molded cage

[Main applications] Automobile : front and rear wheels, transmissions, electric devices
 Electric equipment : standard motors, electric appliances for domestic use
 Others : measuring instruments, internal combustion engines, construction equipment, railway rolling stock, cargo transport equipment, agricultural equipment, equipment for other industrial uses

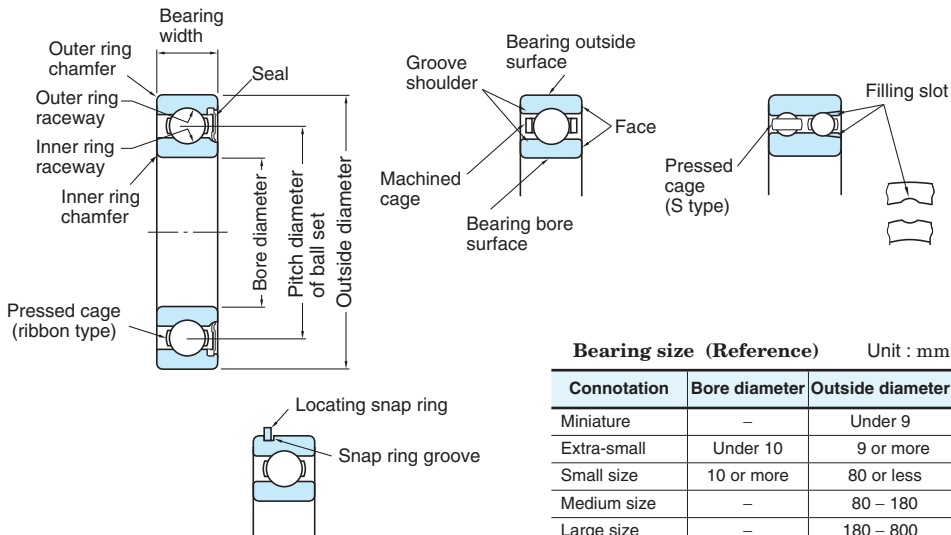

Bearing size (Reference) Unit : mm

Connotation	Bore diameter	Outside diameter
Miniature	-	Under 9
Extra-small	Under 10	9 or more
Small size	10 or more	80 or less
Medium size	-	80 - 180
Large size	-	180 - 800
Extra-large size	-	Over 800

Table 1-2 Angular contact ball bearings

Single-row		Matched pair			Double-row		
		For high-speed use	Back-to-back arrangement	Face-to-face arrangement	Tandem arrangement		
(With pressed cage)	(With machined cage)	HAR	DB	DF	DT	(With filling slot)	
7000, 7200, 7300, 7400	7000B, 7200B, 7300B, 7400B	Contact angle 30°			3200	5200	
7900C, 7000C, 7200C, 7300C	HAR900C, HAR000C	Contact angle 40°			3300	5300	
			Contact angle 15°			Contact angle 32°	Contact angle 24°

- Bearing rings and balls possess their own contact angle which is normally 15°, 30° or 40°.
 - { Larger contact angle ... higher resistance against axial load
 - { Smaller contact angle ... more advantageous for high-speed rotation }
- Single-row bearings can accommodate radial load and axial load in one direction.
- DB and DF matched pair bearings and double-row bearings can accommodate radial load and axial load in both directions. DT matched pair bearings are used for applications where axial load in one direction is too large for one bearing to accept.
- HAR type high speed bearings were designed to contain more balls than standard bearings by minimizing the ball diameter, to offer improved performance in machine tools.
- Angular contact ball bearings are used for high accuracy and high-speed operation.

■ Axial load in both directions and radial load can be accommodated by adapting a structure pairing two single-row angular contact ball bearings back to back.

■ For bearings with no filling slot, the sealed type is available.

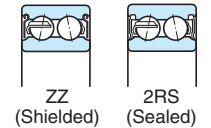

[Recommended cages] Pressed cage (conical type ... single-row : S type, snap type ... double-row), copper alloy or phenolic resin machined cage, synthetic resin molded cage

[Main applications] Single-row : machine tool spindles, high frequency motors, gas turbines, centrifugal separators, front wheels of small size automobiles, differential pinion shafts
 Double-row : hydraulic pumps, roots blowers, air-compressors, transmissions, fuel injection pumps, printing equipment

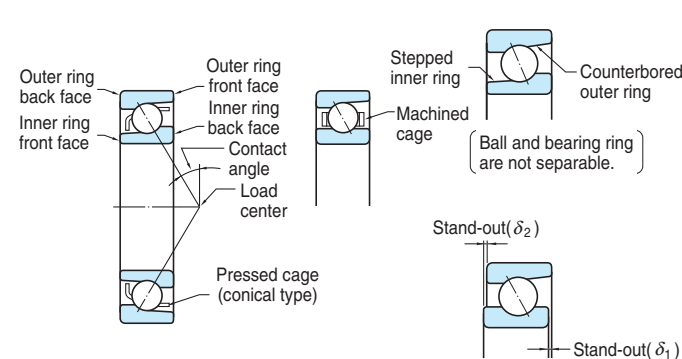

Contact angles (Reference)

Contact angle	Supplementary code
15°	C
20°	CA
25°	AC
30°	A (Omitted)
35°	E
40°	B

"G type" bearings are processed (with flush ground) such that the stand-out turns out to be $\delta_1 = \delta_2$. The matched pair DB, DF, and DT, or stack are available.

1. Rolling bearing structures and types

Table 1-3 Four-point contact ball bearings

One-piece type	Two-piece inner ring	Two-piece outer ring
—	6200BI 6300BI	(6200BO) (6300BO)

- Radial load and axial load in both directions can be accommodated.
- A four-point contact ball bearing can substitute for a face-to-face or back-to-back arrangement of angular contact ball bearings.
- Suitable for use under pure axial load or combined radial and axial load with heavy axial load.
- This type of bearing possesses a contact angle (α) determined in accordance with the axial load direction. This means that the bearing ring and balls contact each other at two points on the lines forming the contact angle.

[Recommended cage] Copper alloy machined cage

[Main applications]

- Motorcycle : Transmission, driveshaft pinion-side
- Automobile : Steering, transmission

Table 1-4 Self-aligning ball bearings

Cylindrical bore	Tapered bore	Sealed
120, 130 1200, 1300 2200, 2300	K (Taper 1 : 12) 11200, 11300... (extended inner ring type)	2RS 2200 2RS 2300 2RS

- Spherical outer ring raceway allows self-alignment, accommodating shaft or housing deflection and misaligned mounting conditions.
- Tapered bore design can be mounted readily using an adapter.

Pressed cage (staggered type...12, 13, 22...2RS, 23...2RS)
snap type22, 23

Power transmission shaft of wood working and spinning machines, plummer blocks

Table 1-5 Cylindrical roller bearings

Single-row						Double-row		Four-row
NU	NJ	NUP	N	NF	NH	NN	NNU	(Mainly use on rolling mill roll neck)
NU1000,	NU200 (R), NU2200 (R), NU3200,	NU300 (R), NU2300 (R), NU3300	NU300 (R), NU400	NU400		Cylindrical bore NNU4900 NN3000	Tapered bore NNU4900K NN3000K	(FC) , (4CR)

- Since the design allowing linear contact of cylindrical rollers with the raceway provides strong resistance to radial load, this type is suitable for use under heavy radial load and impact load, as well as at high speed.
- N and NU types are ideal for use on the free side: they are movable in the shaft direction in response to changes in bearing position relative to the shaft or housing, which are caused by heat expansion of the shaft or improper mounting.

- NJ and NF types can accommodate axial load in one direction; and NH and NUP types can accommodate partial axial load in both directions.
- With separable inner and outer ring, this type ensures easy mounting.
- Due to their high rigidity, NNU and NN types are widely used in machine tool spindles.

[Recommended cages] Pressed cage (Z type), copper alloy machined cage, pin type cage, synthetic resin molded cage

[Main applications] Large and medium size motors, traction motors, generators, internal combustion engines, gas turbines, machine tool spindles, speed reducers, cargo transport equipment, and other industrial equipment

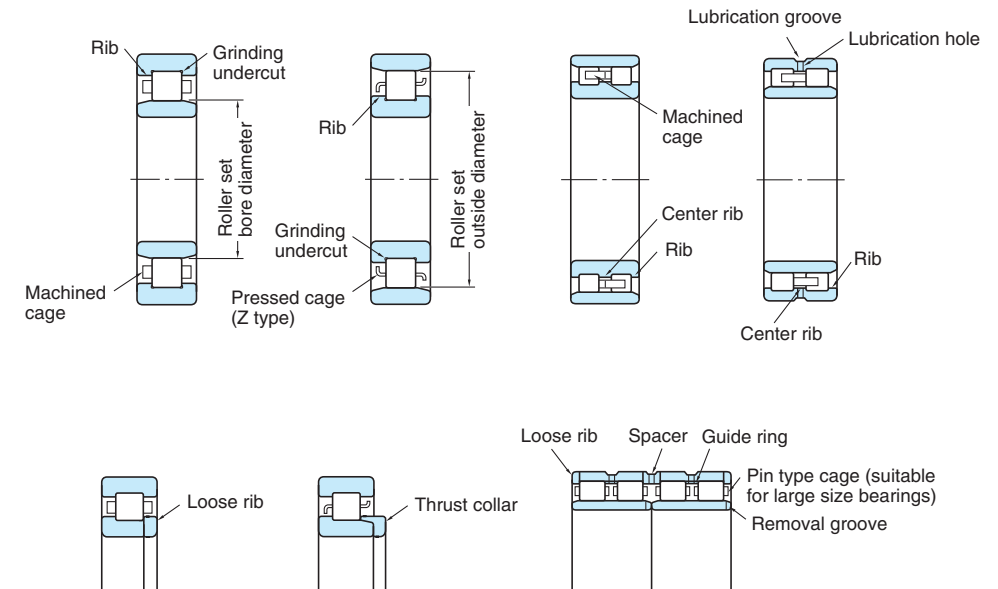
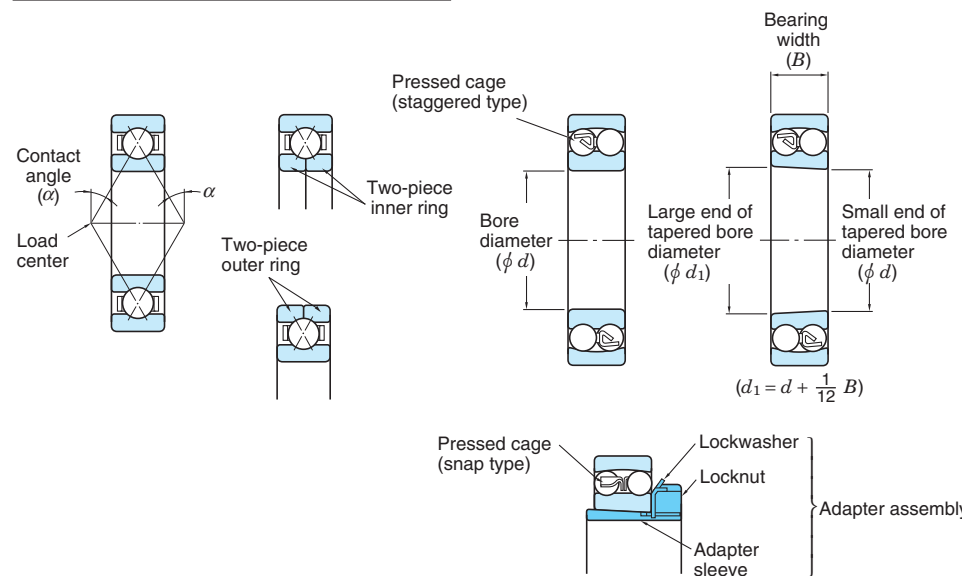

1. Rolling bearing structures and types

Table 1-6 Machined ring needle roller bearings

Single-row			Double-row	
With inner ring	Without inner ring	Sealed	With inner ring	Without inner ring
NA4800 NA4900 NA6900 (NKJ, NKJS)	RNA4800 RNA4900 RNA6900 (NK, NKS, HJ)	NA49002RS - (HJ.2RS)	NA6900 (d ≥ 32)	RNA6900 (Fw ≥ 40)

- In spite of their basic structure, which is the same as that of NU type cylindrical roller bearings, bearings with minimum ring sections offer space savings and greater resistance to radial load, by using needle rollers.
- Bearings with no inner rings function using heat treated and ground shafts as their raceway surface.

[Recommended cage] Pressed cage

[Main applications] Automobile engines, transmissions, pumps, power shovel wheel drums, hoists, overhead traveling cranes, compressors

(Reference) Many needle roller bearings other than those with machined ring are available. For details, refer to the pages for the needle roller bearing specification tables and the dedicated "Needle Roller Bearings" catalog (CAT No. B2020E), published separately.

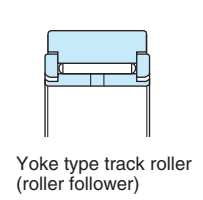
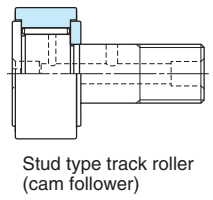
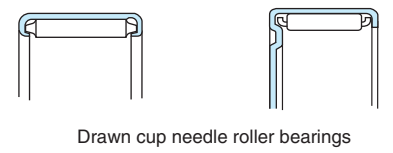
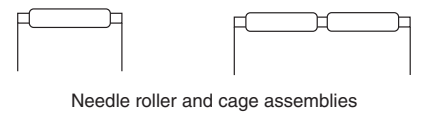
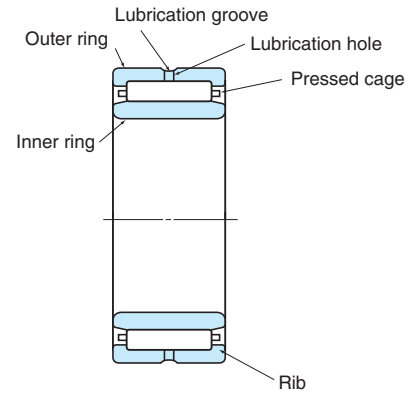

Table 1-7 Tapered roller bearings

Single-row			Double-row		Four-row
		Flanged type			
(Standard contact angle)	(Intermediate contact angle)	(Steep contact angle)	46200 46200A 46300 46300A (46T)	45200 45300 (45T)	(Mainly used on rolling mill roll necks)
32900JR 32000JR 32000JR 33000JR 33100JR	30200JR 32200JR 30300CR 30300DJ 30300DJR 30300CR 32300CR	30200CR 30300DJ 30300DJR 31300JR 32300CR			37200 47200 47300 (47T) (4TR)

- Tapered rollers assembled in the bearings are guided by the inner ring back face rib.
- The raceway surfaces of inner ring and outer ring and the rolling contact surface of rollers are designed so that the respective apexes converge at a point on the bearing center line.
- Single-row bearings can accommodate radial load and axial load in one direction, and double-row bearings can accommodate radial load and axial load in both directions.
- This type of bearing is suitable for use under heavy load or impact load.
- Bearings are classified into standard, intermediate and steep types, in accordance with their contact angle (α). The larger the contact angle is, the greater the bearing resistance to axial load.
- Since outer ring and inner ring assembly can be separated from each other, mounting is easy.
- Bearings designated by the suffix "J" and "JR" are interchangeable internationally.
- Items sized in inches are still widely used.

[Recommended cages] Pressed cage, synthetic resin molded cage, pin type cage

[Main applications] Automobile : front and rear wheels, transmissions, differential pinion
Others : machine tool spindles, construction equipment, large size agricultural equipment, railway rolling stock speed reduction gears, rolling mill roll necks and speed reducers, etc

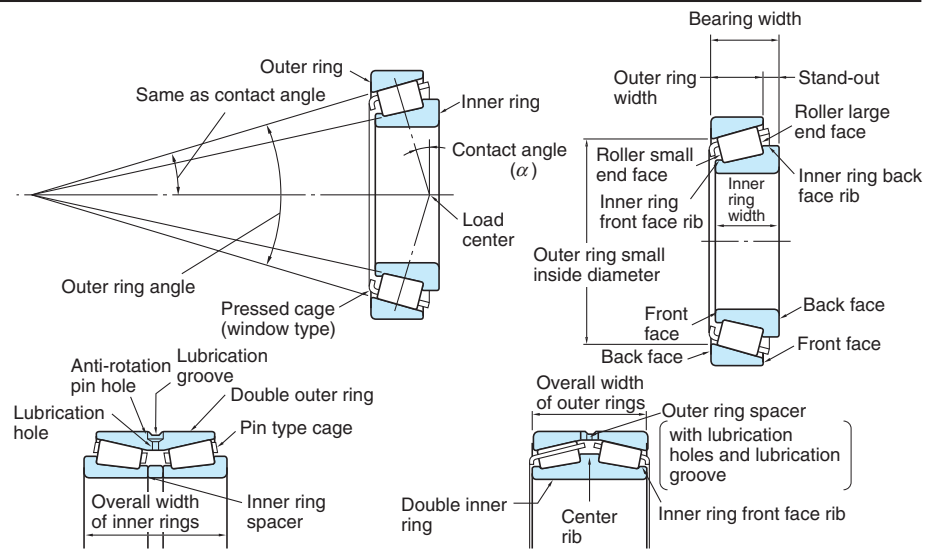

Table 1-8 Spherical roller bearings

Convex asymmetrical roller type	Cylindrical bore		Tapered bore
	Convex symmetrical roller type		
R, RR	RZ	RHA	K or K30
23900R, 23000R (RZ, RHA), 23100R (RZ, RHA), 22200R (RZ, RHA), 21300R (RZ), 24000R (RZ, RHA), 24100R (RZ, RHA), 23200R (RZ, RHA), 22300R (RZ, RHA)			

■ Spherical roller bearings comprising barrel-shaped convex rollers, double-row inner ring and outer ring are classified into three types : R(RR), RZ and RHA, according to their internal structure.

■ With the bearing designed such that the circular arc center of the outer ring raceway matches with the bearing center, the bearing is self-aligning, insensitive to errors of alignment of the shaft relative to the housing, and to shaft bending.

■ This type can accommodate radial load and axial load in both directions, which makes it especially suitable for applications in which heavy load or impact load is applied.

■ The tapered bore type can be easily mounted/dismounted by using an adapter or withdrawal sleeve.

There are two types of tapered bores (tapered ratio) :

- 1 : 30 (supplementary code K30) ... Suitable for series 240 and 241.
- 1 : 12 (supplementary code K) ... Suitable for series other than 240 and 241.

■ Lubrication holes, a lubrication groove and anti-rotation pin hole can be provided on the outer ring. Lubrication holes and a lubrication groove can be provided on the inner ring, too.

[Recommended cages] Copper alloy machined cage, pressed cage

[Main applications] Paper manufacturing equipment, speed reducers, railway rolling stock axle journals, rolling mill pinion stands, table rollers, crushers, shaker screens, printing equipment, wood working equipment, speed reducers for various industrial uses, plummer blocks

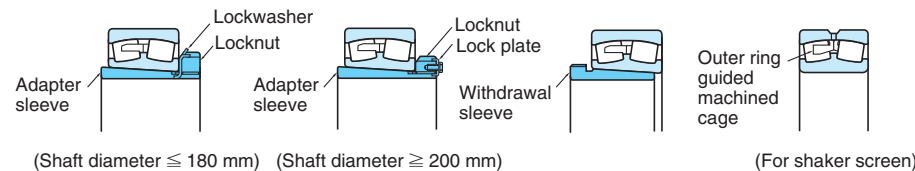
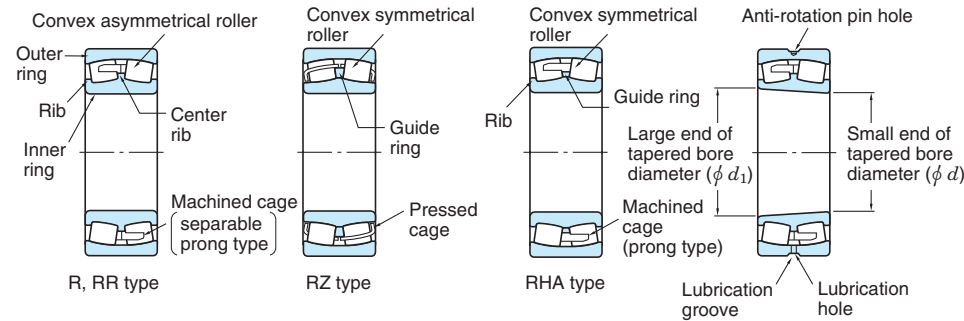

Table 1-9 Thrust ball bearings

Single direction			Double direction		
With flat back faces	With spherical back face	With aligning seat race	With flat back faces	With spherical back faces	With aligning seat races
51100	-	-	-	-	-
51200	53200	53200U	52200	54200	54200U
51300	53300	53300U	52300	54300	54300U
51400	53400	53400U	52400	54400	54400U

■ This type of bearing comprises washer-shaped rings with raceway groove and ball and cage assembly.

■ Races to be mounted on shafts are called shaft races (or inner rings); and, races to be mounted into housings are housing races (or outer rings). Central races of double direction bearings are mounted on the shafts.

■ Single direction bearings accommodate axial load in one direction, and double direction bearings accommodate axial load in both directions. (Both of these bearings cannot accommodate radial loads.)

■ Since bearings with a spherical back face are self-aligning, it helps to compensate for mounting errors.

[Recommended cages] Pressed cage, copper alloy or phenolic resin machined cage, synthetic resin molded cage

[Main applications] Automobile king pins, machine tool spindles

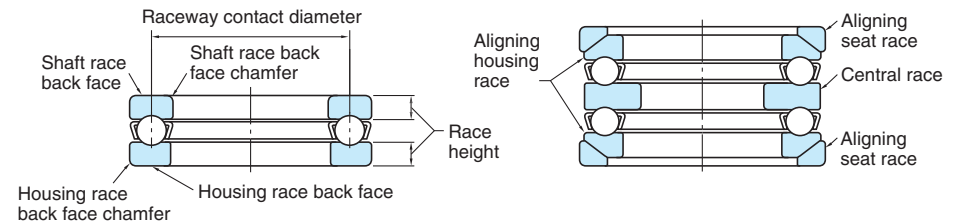
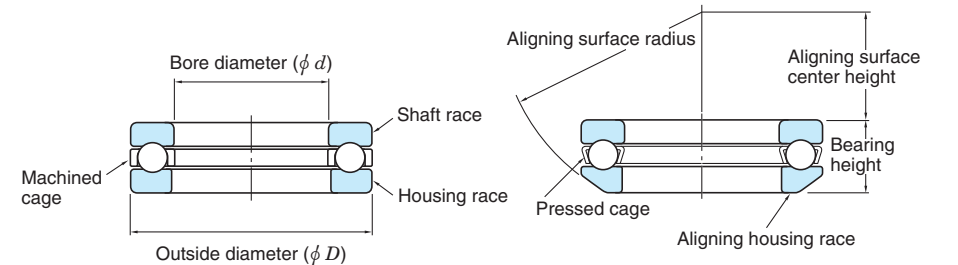

[Remark] The race indicates the washer specified in JIS.

1. Rolling bearing structures and types

Table 1-10 Cylindrical roller thrust bearings

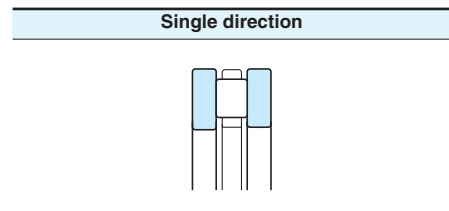

(811, 812, NTHA)

- This type of bearing comprises washer-shaped rings (shaft and housing race) and cylindrical roller and cage assembly.
- Crowned cylindrical rollers produce uniform pressure distribution on roller/raceway contact surface.
- Axial load can be accommodated in one direction.
- Great axial load resistance and high axial rigidity are provided.

[Recommended cages] Copper alloy machined cage

[Main applications] Oil excavators, iron and steel equipment

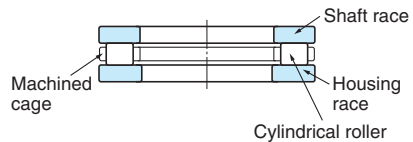
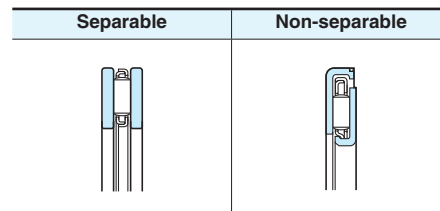

Table 1-11 Needle roller thrust bearings



(AXK, FNT, NTA)

(FNTKF)

- The separable type, comprising needle roller and cage thrust assembly and a race, can be matched with a pressed thin race (AS) or machined thick race (LS, WS.811, GS.811).
- The non-separable type comprises needle roller and cage thrust assembly and a precision pressed race.
- Axial load can be accommodated in one direction.
- Due to the very small installation space required, this type contributes greatly to size reduction of application equipment.
- In many cases, needle roller and cage thrust assembly function by using the mounting surface of the application equipment, including shafts and housings, as its raceway surface.

Pressed cage, synthetic resin molded cage

Transmissions for automobiles, cultivators and machine tools

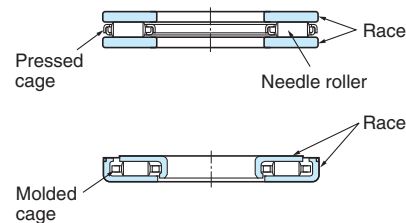

[Remark] The race indicates the thrust washer or washer specified in JIS.

Table 1-12 Tapered roller thrust bearings

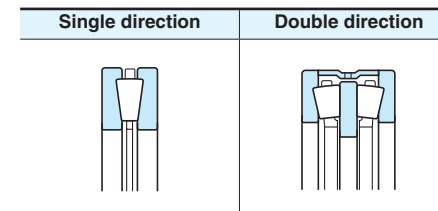

(T)
(THR)

(2THR)

- This type of bearing comprises tapered rollers (with spherical large end), which are uniformly guided by ribs of the shaft and housing races.
- Both shaft and housing races and rollers have tapered surfaces whose apexes converge at a point on the bearing axis.
- Single direction bearings can accommodate axial load in one direction; and, double direction bearings can accommodate axial load in both directions.
- Double direction bearings are to be mounted such that their central race is placed on the shaft shoulder. Since this type is treated with a clearance fit, the central race must be fixed with a sleeve, etc.

[Recommended cages] Copper alloy machined cage

[Main applications]

Single direction : crane hooks, oil excavator swivels
Double direction : rolling mill roll necks

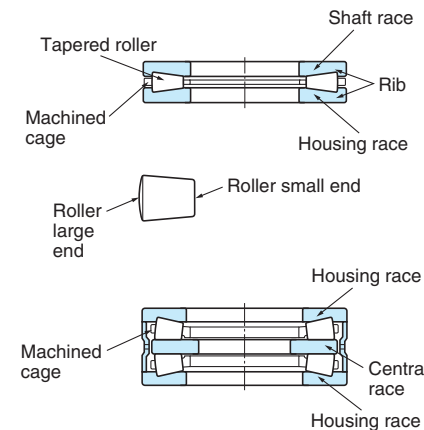
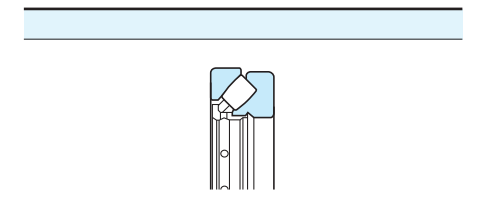

Table 1-13 Spherical thrust roller bearings



29200
29300
29400

- This type of bearing, comprising barrel-shaped convex rollers arranged at an angle with the axis, is self-aligning due to spherical housing race raceway; therefore, shaft inclination can be compensated for to a certain degree.
- Great axial load resistance is provided. This type can accommodate a small amount of radial load as well as heavy axial load.
- Normally, oil lubrication is employed.

Copper alloy machined cage

Hydroelectric generators, vertical motors, propeller shafts for ships, screw down speed reducers, jib cranes, coal mills, pushing machines, molding machines

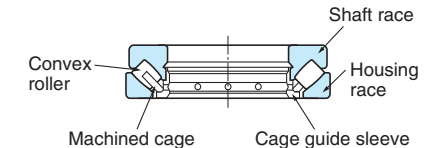

2. Outline of bearing selection

Currently, as bearing design has become diversified, their application range is being increasingly extended. In order to select the most suitable bearings for an application, it is necessary to conduct a comprehensive study on both bearings and the equipment in which the bearings will be installed, including operating conditions, the performance required of the

bearings, specifications of the other components to be installed along with the bearings, marketability, and cost performance, etc.

In selecting bearings, since the shaft diameter is usually determined beforehand, the prospective bearing type is chosen based upon installation space, intended arrangement, and according to the bore diameter required.

Next, from the bearing specifications are determined the service life required when compared to that of the equipment in which it is used, along with a calculation of the actual service life from operational loads.

Internal specifications including bearing accuracy, internal clearance, cage, and lubricant are also selected, depending on the application.

For reference, general selection procedure and operating conditions are described in Fig. 2-1. There is no need to follow a specific order, since the goal is to select the right bearing to achieve optimum performance.

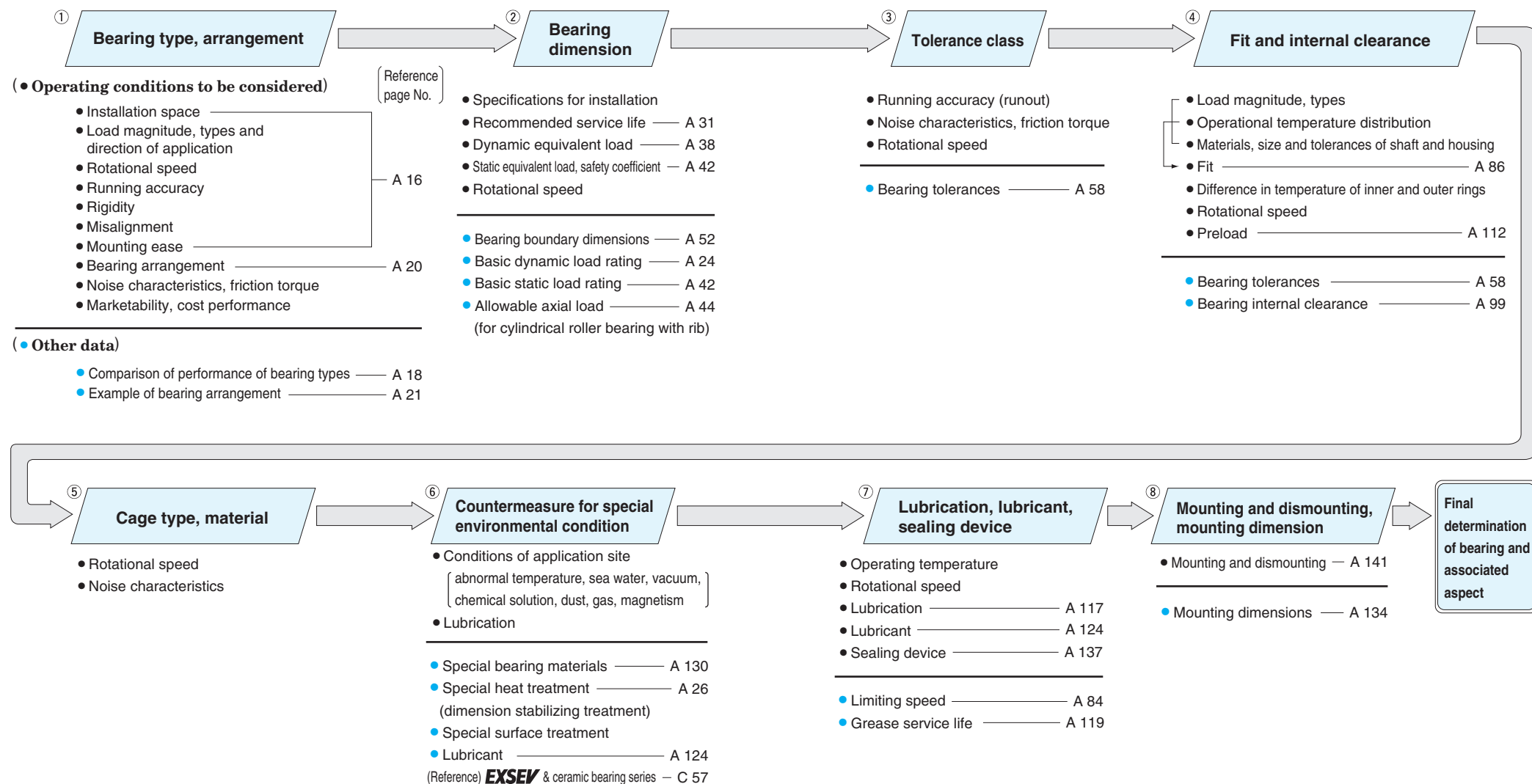

Fig. 2-1(1) Bearing selection procedure

Fig. 2-1(2) Bearing selection procedure

3. Selection of bearing type

In selecting bearings, the most important thing is to fully understand the operating conditions of the bearings.

The main factors to be considered are listed in Table 3-1, while bearing types are listed in Table 3-2.

Table 3-1 (1) Selection of bearing type

Items to be considered	Selection method	Reference page No.
1) Installation space Bearing can be installed in target equipment	<ul style="list-style-type: none"> When a shaft is designed, its rigidity and strength are considered essential; therefore, the shaft diameter, i.e., bore diameter, is determined at start. For rolling bearings, since wide variety with different dimensions are available, the most suitable bearing type should be selected. (Fig. 3-1) 	A 52
2) Load Load magnitude, type and direction which applied (Load resistance of bearing is specified in terms of the basic load rating, and its value is specified in the bearing specification table.)	<ul style="list-style-type: none"> Since various types of load are applied to bearings, load magnitude, types (radial or axial) and direction of application (both directions or single direction in the case of axial load), as well as vibration and impact must be considered in order to select the proper bearing. The following is the general order for radial resistance ; (deep groove ball bearings < angular contact ball bearings < cylindrical roller bearings < tapered roller bearings < spherical roller bearings) 	A 18 (Table 3-2) A 87
3) Rotational speed Response to rotational speed of equipment in which bearings will be installed (The limiting speed for bearing is expressed as allowable speed, and this value is specified in the bearing specification table.)	<ul style="list-style-type: none"> Since the allowable speed differs greatly depending not only upon bearing type but on bearing size, cage, accuracy, load and lubrication, all factors must be considered in selecting bearings. In general, the following bearings are the most widely used for high speed operation. (deep groove ball bearings, angular contact ball bearings, cylindrical roller bearings) 	A 18 (Table 3-2) A 84
4) Running accuracy Accurate rotation delivering required performance (Dimension accuracy and running accuracy of bearings are provided by JIS, etc.)	<ul style="list-style-type: none"> Performance required differs depending on equipment in which bearings are installed : for instance, machine tool spindles require high running accuracy, gas turbines require high speed rotation, and control equipment requires low friction. In such cases, bearings of tolerance class 5 or higher are required. The following are the most widely used bearings. (deep groove ball bearings, angular contact ball bearings, cylindrical roller bearings) 	A 18 (Table 3-2) A 58
5) Rigidity Rigidity that delivers the bearing performance required (When load is applied to a bearing, elastic deformation occurs at the point where its rolling elements contact the raceway surface. The higher the rigidity that bearings possess, the better they control elastic deformation.)	<ul style="list-style-type: none"> In machine tool spindles and automobile final drives, bearing rigidity as well as rigidity of equipment itself must be enhanced. Elastic deformation occurs less in roller bearings than in ball bearings. Rigidity can be enhanced by providing preload. This method is suitable for use with angular contact ball bearings and tapered roller bearings. 	A 18 (Table 3-2) A 112

Table 3-1 (2) Selection of bearing type

Items to be considered	Selection method	Reference page No.
6) Misalignment (aligning capability) Operating conditions which cause misalignment (shaft deflection caused by load, inaccuracy of shaft and housing, mounting errors) can affect bearing performance (Allowable misalignment (in angle) for each bearing type is described in the section before the bearing specification table, to facilitate determination of the self-aligning capability of bearings.)	<ul style="list-style-type: none"> Internal load caused by excessive misalignment damages bearings. Bearings designed to absorb such misalignment should be selected. The higher the self-aligning capability that bearings possess, the larger the angular misalignment that can be absorbed. The following is the general order of bearings when comparing allowable angular misalignment : (cylindrical roller bearings < tapered roller bearings < deep groove ball bearings, angular contact ball bearings < spherical roller bearings, self-aligning ball bearings) 	A 18 (Table 3-2)
7) Mounting and dismounting Methods and frequency of mounting and dismounting required for periodic inspection	<ul style="list-style-type: none"> Cylindrical roller bearings, needle roller bearings and tapered roller bearings, with separable inner and outer rings, are recommended for applications in which mounting and dismounting is conducted frequently. Use of sleeve eases the mounting of self-aligning ball bearings and spherical roller bearings with tapered bore. 	A 18 (Table 3-2)

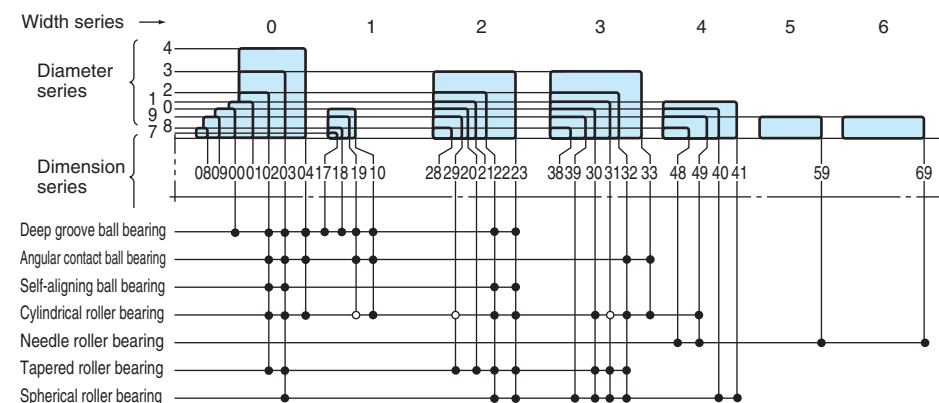

Fig. 3-1 Radial bearing dimension series

Table 3-2 Performance comparison of bearing type

	Deep groove ball bearing	Angular contact ball bearing			Four-point contact ball bearing	Self-aligning ball bearing	Cylindrical roller bearing					Needle roller bearing (machined ring type)	Tapered roller bearing		Spherical roller bearing	Thrust ball bearing		Double direction angular contact thrust ball bearing	Cylindrical roller thrust bearing	Needle roller thrust bearing	Tapered roller thrust bearing	Spherical thrust roller bearing	Reference page No.
		Single-row	Matched pair or stack	Double-row			NU · N	NJ · NF	NUP · NH	NN · NNU			Single-row	Double-row, four-row		With flat back faces	With aligning seat race						
Load resistance	Radial load	○	○	◎	◎	○	○	◎	◎	◎	◎	◎	◎	◎	◎	×	×	×	×	×	×	△	—
	Axial load	○ ↔	◎ ←	◎ ↔*	◎ ↔*	◎ ↔	△ ↔	×	△ ←	△ ↔	×	×	◎ ←	◎ ↔	△ ↔	○ ←*	○ ←*	◎ ↔	◎ ←	◎ ←	◎ ←	◎ ←	—
	Combined load radial and axial	○	○	◎	◎	○	△	×	△	△	×	×	◎	◎	△	×	×	×	×	×	×	△	—
	Vibration or impact load	△	△	△	△	△	△	◎	◎	◎	◎	○	◎	◎	◎	△	△	△	△	○	○	◎	◎
High speed adaptability	◎	◎	◎	○	◎	△	◎	◎	◎	◎	○	○	○	○	△	△	○	△	△	△	△	△	A16 A84
High accuracy	◎	◎	◎		◎		◎			◎		○			○		◎						A16, 58 A117
Low noise level/low torque	◎						○																A16
Rigidity			○		○		○	○	○	◎		○	○	◎			○	◎	◎	◎			A16
Misalignment	○	△	×	×	×	◎	△	△	△	△		△	△	△	◎	×	◎	×	×	×	×	◎	A17 Description before specification table
Inner and outer ring separability	×	×	×	×	■*	×	■	■	■	■		■	■	■	×	■	■	■	■	■*	■	■	—
Arrangement	Fixed side	■ ↔	■ ←	■ ↔	■ ↔*	■ ↔	■ ↔	×	■ ←	■ ↔	×	×	■ ←	■ ↔	■ ↔								A20
	Free side	□		□	□	□	■	□	□	■		■		□	□								A20
Remarks		A pair of bearings mounted facing each other.	*DT arrangement is effective for one direction only.	*Filling slot type is effective for one direction only.	*Non-separable type is also available.							A pair of bearings mounted facing each other.				*Double direction bearings are effective for both directions.				*Non-separable type is also available.			—
Reference page No.	A4 B4	A5 B54		A6 —	A6 B124	A7 B138					A8 B362	A9 B184		A10 B290	A11 B336		— —	A12 B448	A12 B444	A13 —	A13 B354	—	

◎ Excellent ○ Good △ Fair × Unacceptable ↔ Both directions ← One direction only ■ Acceptable □ Acceptable, but shaft shrinkage must be compensated for.

4. Selection of bearing arrangement

As bearing operational conditions vary depending on devices in which bearings are mounted, different performances are demanded of bearings. Normally, two or more bearings are used on one shaft.

In many cases, in order to locate shaft positions in the axial direction, one bearing is mounted on the fixed side first, then the other bearing is mounted on the free side.

Table 4-1 Bearings on fixed and free sides

	Features	Recommended bearing type	Example No.
Fixed side bearing	<ul style="list-style-type: none"> This bearing determines shaft axial position. This bearing can accommodate both radial and axial loads. Since axial load in both directions is imposed on this bearing, strength must be considered in selecting the bearing for this side. 	Deep groove ball bearing Matched pair or stack angular contact ball bearing Double-row angular contact ball bearing Self-aligning ball bearing Cylindrical roller bearing with rib (NUP and NH types) Double-row tapered roller bearing Spherical roller bearing	Examples 1-11
Free side bearing	<ul style="list-style-type: none"> This bearing is employed to compensate for expansion or shrinkage caused by operating temperature change and to allow adjustment of bearing position. Bearings which accommodate radial load only and whose inner and outer rings are separable are recommended as free side bearings. In general, if non-separable bearings are used on free side, clearance fit is provided between outer ring and housing to compensate for shaft movement through bearings. In some cases, clearance fit between shaft and inner ring is utilized. 	<ul style="list-style-type: none"> Separable types Cylindrical roller bearing (NU and N types) Needle roller bearing (NA type, etc.) Non-separable types Deep groove ball bearing Matched pair angular contact ball bearing (Back-to-back arrangement) Double-row angular contact ball bearing Self-aligning ball bearing Double-row tapered roller bearing (TDO type) Spherical roller bearing 	
When fixed and free sides are not distinguished	<ul style="list-style-type: none"> When bearing intervals are short and shaft shrinkage does not greatly affect bearing operation, a pair of angular contact ball bearings or tapered roller bearings is used in paired mounting to accommodate axial load. After mounting, the axial clearance is adjusted using nuts or shims. 	Deep groove ball bearing Angular contact ball bearing Self-aligning ball bearing Cylindrical roller bearing (NJ and NF types) Tapered roller bearing Spherical roller bearing	Examples 12-16
Bearings for vertical shafts	<ul style="list-style-type: none"> Bearings which can accommodate both radial and axial loads should be used on fixed side. Heavy axial load can be accommodated using thrust bearings together with radial bearings. Bearings which can accommodate radial load only are used on free side, compensating for shaft movement. 	<ul style="list-style-type: none"> Fixed side Matched pair angular contact ball bearing (Back-to-back arrangement) Double-row tapered roller bearing (TDO type) Thrust bearing + radial bearing 	Examples 17 and 18

Table 4-2 (1) Example bearing arrangements

Example	Bearing arrangement		Recommended application	Application example
	Fixed side	Free side		
Ex. 1			<ul style="list-style-type: none"> Suitable for high-speed operation; used for various types of applications. Not recommended for applications that have center displacement between bearings or shaft deflection. 	Medium size motors, air blowers
Ex. 2			<ul style="list-style-type: none"> More suitable than Ex. 1 for operation under heavy load or impact load. Suitable also for high-speed operation. Due to separability, suitable for applications requiring interference of both inner and outer rings. Not recommended for applications that have center displacement between bearings or shaft deflection. 	Traction motors for railway rolling stock
Ex. 3			<ul style="list-style-type: none"> Recommended for applications under heavier or greater impact load than those in Ex. 2. This arrangement requires high rigidity from fixed side bearings mounted back to back, with preload provided. Shaft and housing of accurate dimensions should be selected and mounted properly. 	Steel manufacturing table rollers, lathe spindles
Ex. 4			<ul style="list-style-type: none"> This is recommended for operation at high speed or axial load lighter than in Ex. 3. This is recommended for applications requiring interference of both inner and outer rings. Some applications use double-row angular contact ball bearings on fixed side instead of matched pair angular contact ball bearings. 	Motors
Ex. 5			<ul style="list-style-type: none"> This is recommended for operations under relatively small axial load. This is recommended for applications requiring interference of both inner and outer rings. 	Paper manufacturing calender rollers, diesel locomotive axle journals
Ex. 6			<ul style="list-style-type: none"> This is recommended for operations at high speed and heavy radial load, as well as normal axial load. When deep groove ball bearings are used, clearance must be provided between outside diameter and housing, to prevent application of radial load. 	Diesel locomotive transmissions
Ex. 7			<ul style="list-style-type: none"> This arrangement is most widely employed. This arrangement can accommodate partial axial load as well as radial load. 	Pumps, automobile transmissions

Table 4-2 (2) Example bearing arrangements

Example	Bearing arrangement		Recommended application	Application example
	Fixed side	Free side		
Ex. 8			<ul style="list-style-type: none"> This is recommended for operations with relatively heavy axial load in both directions. Some applications use matched pair angular contact ball bearings on fixed side instead of double-row angular contact ball bearings. 	Worm gear speed reducers
Ex. 9			<ul style="list-style-type: none"> This is the optimum arrangement for applications with possible mounting errors or shaft deflection. Bearings in this arrangement can accommodate partial axial load, as well as heavy radial load. 	Steel manufacturing table roller speed reducers, overhead crane wheels
Ex. 10			<ul style="list-style-type: none"> This is optimum arrangement for applications with possible mounting errors or shaft deflection. Ease of mounting and dismounting, ensured by use of adaptor, makes this arrangement suitable for long shafts which are neither stepped nor threaded. This arrangement is not recommended for applications requiring axial load capability. 	General industrial equipment counter shafts
Ex. 11			<ul style="list-style-type: none"> This is the optimum arrangement for applications with possible mounting errors or shaft deflection. This is recommended for operations under impact load or radial load heavier than that in Ex. 10. This arrangement can accommodate partial axial load as well as radial load. 	Steel manufacturing table rollers
Arrangement in which fixed and free sides are not distinguished			Recommended application	Application example
Ex. 12			<ul style="list-style-type: none"> This arrangement is most popular when applied to small equipment operating under light load. When used with light preloading, thickness-adjusted shim or spring is mounted on one side of outer ring. 	Small motors, small speed reducers, small pumps
Ex. 13			<ul style="list-style-type: none"> This is suitable for applications in which rigidity is enhanced by preloading. This is frequently employed in applications requiring high speed operation under relatively large axial load. Back-to-back arrangement is suitable for applications in which moment load affects operation. When preloading is required, care should be taken in preload adjustment. 	Machine tool spindles

Table 4-2 (3) Example bearing arrangements

Example	Arrangement in which fixed and free sides are not distinguished	Recommended application	Application example
Ex. 14		<ul style="list-style-type: none"> This is recommended for operation under impact load or axial load heavier than in Ex. 13. This is suitable for applications in which rigidity is enhanced by preloading. Back-to-back arrangement is suitable for applications in which moment load affects operation. When interference is required between inner ring and shaft, face-to-face arrangement simplifies mounting. This arrangement is effective for applications in which mounting error is possible. When preloading is required, care should be taken in preload adjustment. 	Speed reducers, automobile wheels
Ex. 15		<ul style="list-style-type: none"> This is recommended for applications requiring high speed and high accuracy of rotation under light load. This is suitable for applications in which rigidity is enhanced by preloading. Tandem arrangement and face-to-face arrangement are possible, as is back-to-back arrangement. 	Machine tool spindles
Ex. 16		<ul style="list-style-type: none"> This arrangement provides resistance against heavy radial and impact loads. This is applicable when both inner and outer rings require interference. Care should be taken not to reduce axial internal clearance a critical amount during operation. 	Construction equipment final drive
Application to vertical shafts		Recommended application	Application example
Ex. 17		<ul style="list-style-type: none"> This arrangement, using matched pair angular contact ball bearings on the fixed side and cylindrical roller bearings on the free side, is suitable for high speed operation. 	Vertical motors, vertical pumps
Ex. 18		<ul style="list-style-type: none"> This is recommended for operation at low speed and heavy load, in which axial load is heavier than radial load. Due to self-aligning capability, this is suitable for applications in which shaft runout or deflection occurs. 	Crane center shafts, vertical pumps

5. Selection of bearing dimensions

5-1 Bearing service life

When bearings rotate under load, material flakes from the surfaces of inner and outer rings or rolling elements by fatigue arising from repeated contact stress (ref. A 152).

This phenomenon is called flaking. The total number of bearing rotations until flaking occurs is regarded as the bearing "fatigue" service life. "(Fatigue) service life" differs greatly depending upon bearing structures, dimensions, materials, and processing methods.

Since this phenomenon results from fatigue distribution in bearing materials themselves, differences in bearing service life should be statistically considered.

When a group of identical bearings are rotated under the same conditions, the total number of revolutions until 90 % of the bearings are left without flaking (i.e. a service life of 90 % reliability) is defined as the basic rating life. In operation at a constant speed, the basic rating life can be expressed in terms of time.

In actual operation, a bearing fails not only because of fatigue, but other factors as well, such as wear, seizure, creeping, fretting, brinelling, cracking etc (ref. A 152, 16. Examples of bearing failures).

These bearing failures can be minimized by selecting the proper mounting method and lubricant, as well as the bearing most suitable for the application.

5-2 Calculation of service life

5-2-1 Basic dynamic load rating C

The basic dynamic load rating is either pure radial (for radial bearings) or central axial load (for thrust bearings) of constant magnitude in a constant direction, under which the basic rating life of 1 million revolutions can be obtained, when the inner ring rotates while the outer ring is stationary, or vice versa. The basic dynamic load rating, which represents the capacity of a bearing under rolling fatigue, is specified as the basic dynamic radial load rating (C_r) for radial bearings, and basic dynamic axial load rating (C_a) for thrust bearings. These load ratings are listed in the specification table.

These values are prescribed by ISO 281/1990, and are subject to change by conformance to the latest ISO standards.

5-2-2 Basic rating life L_{10}

The basic rating life L_{10} is a service life of 90 % reliability when used under normal usage conditions for bearings of high manufacturing quality where the inside of the bearing is of a standard design made from bearing steel materials specified in JIS or equivalent materials.

The relationship between the basic dynamic load rating, dynamic equivalent load, and basic rating life of a bearing can be expressed using equation (5-1). This life calculation equation does not apply to bearings that are affected by factors such as plastic deformation of the contact surfaces of raceways and rolling elements due to extremely high load conditions (when P exceeds either the basic static load rating C_0 (refer to p. A 42) or $0.5C$) or, conversely, to bearings that are affected by factors such as the contact surfaces of raceways and rolling elements slipping due to extremely low load conditions.

If conditions like these may be encountered, consult with JTEKT.

It is convenient to express the basic rating life in terms of time, using equation (5-2), when a bearing is used for operation at a constant speed; and, in terms of traveling distance (km), using equation (5-3), when a bearing is used in railway rolling stock or automobiles.

$$\left(\text{Total revolutions} \right) L_{10} = \left(\frac{C}{P} \right)^p \dots\dots\dots(5-1)$$

$$\left(\text{Time} \right) L_{10h} = \frac{10^6}{60n} \left(\frac{C}{P} \right)^p \dots\dots\dots(5-2)$$

$$\left(\text{Running distance} \right) L_{10s} = \pi DL_{10} \dots\dots\dots(5-3)$$

where :

- L_{10} : basic rating life 10^6 revolutions
- L_{10h} : basic rating life h
- L_{10s} : basic rating life km
- P : dynamic equivalent load N
- C : basic dynamic load rating N
- n : rotational speed min⁻¹
- p : for ball bearings..... $p = 3$
- for roller bearings..... $p = 10/3$
- D : wheel or tire diameter mm

Accordingly, where the dynamic equivalent load is P , and rotational speed is n , equation (5-4) can be used to calculate the basic dynamic load rating C ; the bearing size most suitable for a specified purpose can then be selected, referring to the bearing specification table.

The recommended bearing service life differs depending on the machines with which the bearing is used, as shown in Table 5-5, p. A 31.

$$C = P \left(L_{10h} \times \frac{60n}{10^6} \right)^{1/p} \dots\dots\dots(5-4)$$

[Reference]

The equations using a service life coefficient (f_h) and rotational speed coefficient (f_n) respectively, based on equation (5-2), are as follows :

$$L_{10h} = 500 f_h^p \dots\dots\dots(5-5)$$

Coefficient of service life :

$$f_h = \frac{C}{P} \dots\dots\dots(5-6)$$

Coefficient of rotational speed :

$$f_n = \left(\frac{10^6}{500 \times 60n} \right)^{1/p} = (0.03n)^{-1/p} \dots\dots\dots(5-7)$$

For reference, the values of f_n , f_h , and L_{10h} can be easily obtained by employing the nomograph attached to this catalog, as an abbreviated method.

[Ball bearing]

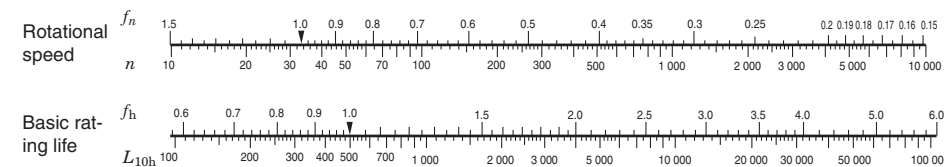

[Roller bearing]

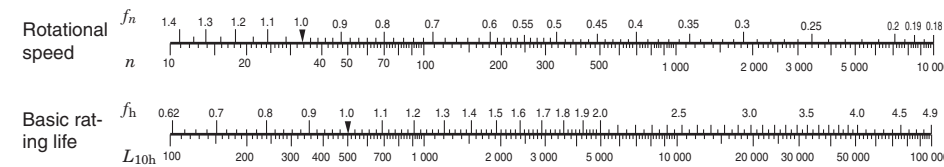

[Reference] Rotational speed (n) and its coefficients (f_n), and service life coefficient (f_h) and basic rating life (L_{10h})

5-2-3 Correction of basic dynamic load rating for high temperature use and dimension stabilizing treatment

In high temperature operation, bearing material hardness deteriorates, as material compositions are altered. As a result, the basic dynamic load rating is diminished. Once altered, material composition is not recovered, even if operating temperatures return to normal.

Therefore, for bearings used in high temperature operation, the basic dynamic load rating should be corrected by multiplying the basic dynamic load rating values specified in the bearing specification table by the temperature coefficient values in Table 5-1.

Table 5-1 Temperature coefficient values

Bearing temperature, °C	125	150	175	200	250
Temperature coefficient	1	1	0.95	0.90	0.75

Since normal heat treatment is not effective in maintaining the original bearing size in extended operation at 120 °C or higher, dimension stabilizing treatment is necessary. Dimension stabilizing treatment codes and their effective temperature ranges are described in Table 5-2.

Since dimension stabilizing treatment diminishes material hardness, the basic dynamic load rating may be reduced for some types of bearings.

Table 5-2 Dimension stabilizing treatment

Dimension stabilizing treatment code	Effective temperature range
S0	Over 100°C, up to 150°C
S1	150°C 200°C
S2	200°C 250°C

5-2-4 Modified rating life L_{nm}

The life of rolling bearings was standardized as a basic rating life in the 1960s, but in actual applications, sometimes the actual life and the basic rating life have been quite different due to the lubrication status and the influence of the usage environment. To make the calculated life closer to the actual life, a corrected rating life has been considered since the 1980s. In this corrected rating life, bearing characteristic factor a_2 (a correction factor for the case in which the characteristics related to the life are changed due to the bearing materials, manufacturing process, and design) and usage condition factor a_3 (a correction factor that takes into account usage conditions that have a direct influence on the bearing life, such as the lubrication) or factor a_{23} formed from the interdependence of these two factors, are considered with the basic rating life. These factors were handled differently by each bearing manufacturer, but they have been standardized as a modified rating life in **ISO 281** in 2007. In 2013, **JIS B 1518** (dynamic load ratings and rating life) was amended to conform to the **ISO**.

The basic rating life (L_{10}) shown in equation (5-1) is the (fatigue) life with a dependability of 90 % under normal usage conditions for rolling bearings that have standard factors such as internal design, materials, and manufacturing quality. **JIS B 1518:2013** specifies a calculation method based on **ISO 281:2007**. To calculate accurate bearing life under a variety of operating conditions, it is necessary to consider elements such as the effect of changes in factors that can be anticipated when using different reliabilities and system approaches, and interactions between factors. Therefore, the specified calculation method considers additional stress due to the lubrication status, lubricant contamination, and fatigue load limit C_u (refer to p. A 29) on the inside of the bearing. The life that uses this life modification factor a_{ISO} , which considers the above factors, is called modified rating life L_{nm} and is calculated with the following equation (5-8).

$$L_{nm} = a_1 a_{ISO} L_{10} \dots\dots\dots (5-8)$$

In this equation,

L_{nm} : Modified rating life 10⁶ rotations
 (This rating life has been modified for one of or a combination of the following: reliability of 90 % or higher, fatigue load limit, special bearing characteristics, lubrication contamination, and special operating conditions.)

L_{10} : Basic rating life 10⁶ rotations (reliability: 90 %)

a_1 : Life modification factor for reliability
 refer to section (1)

a_{ISO} : Life modification factor
 refer to section (2)

[Remark]

When bearing dimensions are to be selected given L_{nm} greater than 90 % in reliability, the strength of shaft and housing must be considered.

(1) Life modification factor for reliability a_1

The term "reliability" is defined as "for a group of apparently identical rolling bearings, operating under the same conditions, the percentage of the group that is expected to attain or exceed a specified life" in **ISO 281:2007**. Values of a_1 used to calculate a modified rating life with a reliability of 90 % or higher (a failure probability of 10 % or less) are shown in Table 5-3.

Table 5-3 Life modification factor for reliability a_1

Reliability, %	L_{nm}	a_1
90	L_{10m}	1
95	L_{5m}	0.64
96	L_{4m}	0.55
97	L_{3m}	0.47
98	L_{2m}	0.37
99	L_{1m}	0.25
99.2	$L_{0.8m}$	0.22
99.4	$L_{0.6m}$	0.19
99.6	$L_{0.4m}$	0.16
99.8	$L_{0.2m}$	0.12
99.9	$L_{0.1m}$	0.093
99.92	$L_{0.08m}$	0.087
99.94	$L_{0.06m}$	0.080
99.95	$L_{0.05m}$	0.077

(Citation from **JIS B 1518:2013**)

(2) Life modification factor a_{ISO}

a) System approach

The various influences on bearing life are dependent on each other. The system approach of calculating the modified life has been evaluated as a practical method for determining life modification factor a_{ISO} (ref. Fig. 5-1). Life modification factor a_{ISO} is calculated with the following equation. A diagram is available for each bearing type (radial ball bearings, radial roller bearings, thrust ball bearings, and thrust roller bearings). (Each diagram (Figs. 5-2 to 5-5) is a citation from **JIS B 1518:2013**.)

Note that in practical use, this is set so that life modification factor $a_{ISO} \leq 50$.

$$a_{ISO} = f \left(\frac{e_c C_u}{P}, \kappa \right) \dots\dots\dots (5-9)$$

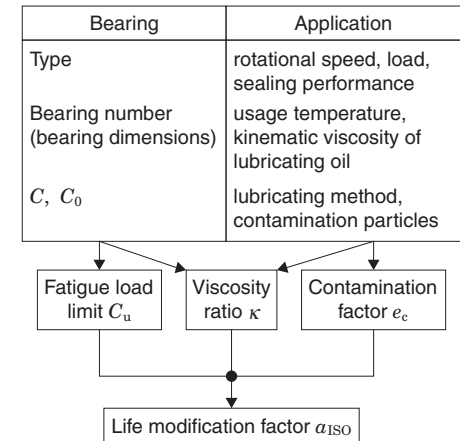

Fig. 5-1 System approach

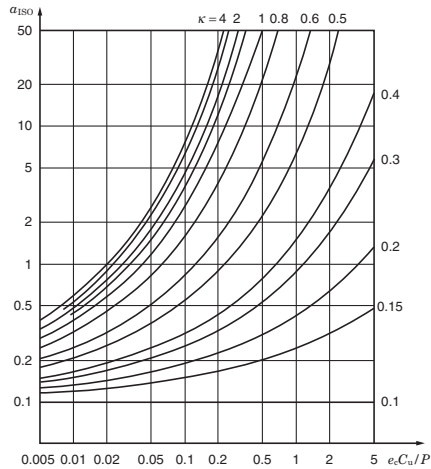

Fig. 5-2 Life modification factor a_{ISO} (Radial ball bearings)

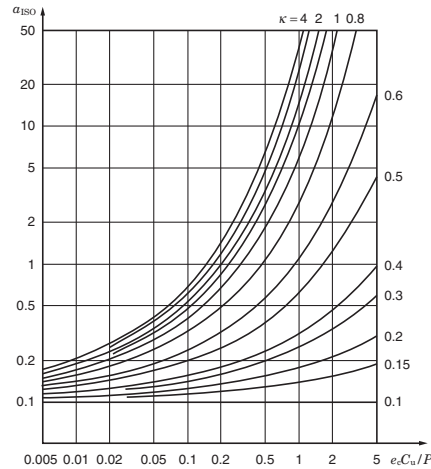

Fig. 5-3 Life modification factor a_{ISO} (Radial roller bearings)

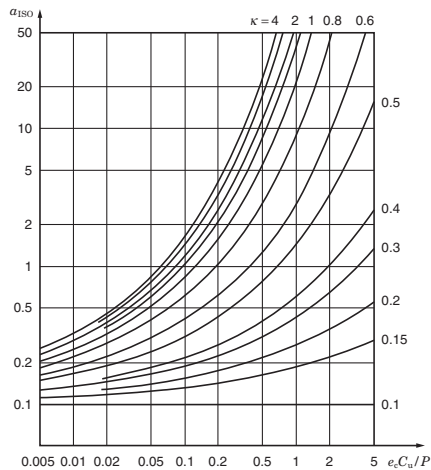

Fig. 5-4 Life modification factor a_{ISO} (Thrust ball bearings)

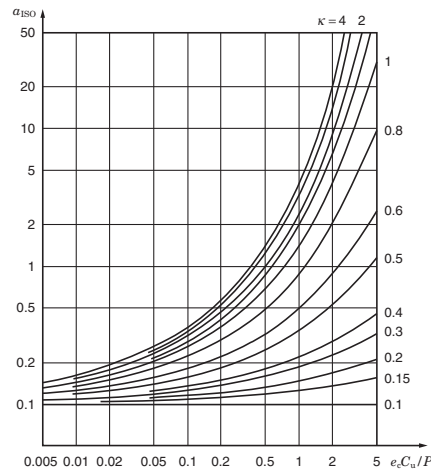

Fig. 5-5 Life modification factor a_{ISO} (Thrust roller bearings)

(Figs. 5-2 to 5-5 Citation from JIS B 1518:2013)

b) Fatigue load limit C_u

For regulated steel materials or alloy steel that has equivalent quality, the fatigue life is unlimited so long as the load condition does not exceed a certain value and so long as the lubrication conditions, lubrication cleanliness class, and other operating conditions are favorable. For general high-quality materials and bearings with high manufacturing quality, the fatigue stress limit is reached at a contact stress of approximately 1.5 GPa between the raceway and rolling elements. If one or both of the material quality and manufacturing quality are low, the fatigue stress limit will also be low.

The term "fatigue load limit" C_u is defined as "bearing load under which the fatigue stress limit is just reached in the most heavily loaded raceway contact" in ISO 281:2007, and is affected by factors such as the bearing type, size, and material.

For details on the fatigue load limits of special bearings and other bearings not listed in this catalog, contact JTEKT.

c) Contamination factor e_c

If solid particles in the contaminated lubricant are caught between the raceway and the rolling elements, indentations may form on one or both of the raceway and the rolling elements. These indentations will lead to localized increases in stress, which will decrease the life. This decrease in life attributable to the contamination of the lubricant can be calculated from the contamination level as contamination factor e_c .

D_{pw} shown in this table is the pitch diameter of ball/roller set, which is expressed simply as $D_{pw} = (D + d)/2$. (D : Outside diameter, d : Bore diameter)

For information such as details on special lubricating conditions or detailed investigations, contact JTEKT.

Table 5-4 Values of contamination factor e_c

Contamination level	e_c	
	$D_{pw} < 100 \text{ mm}$	$D_{pw} \geq 100 \text{ mm}$
Extremely high cleanliness: The size of the particles is approximately equal to the thickness of the lubricant oil film, this is found in laboratory-level environments.	1	1
High cleanliness: The oil has been filtered by an extremely fine filter, this is found with standard grease-packed bearings and sealed bearings.	0.8 to 0.6	0.9 to 0.8
Standard cleanliness: The oil has been filtered by a fine filter, this is found with standard grease-packed bearings and shielded bearings.	0.6 to 0.5	0.8 to 0.6
Minimal contamination: The lubricant is slightly contaminated.	0.5 to 0.3	0.6 to 0.4
Normal contamination: This is found when no seal is used and a coarse filter is used in an environment in which wear debris and particles from the surrounding area penetrate into the lubricant.	0.3 to 0.1	0.4 to 0.2
High contamination: This is found when the surrounding environment is considerably contaminated and the bearing sealing is insufficient.	0.1 to 0	0.1 to 0
Extremely high contamination	0	0

(Table 5-4 Citation from JIS B 1518:2013)

d) Viscosity ratio κ

The lubricant forms an oil film on the roller contact surface, which separates the raceway and the rolling elements. The status of the lubricant oil film is expressed by viscosity ratio κ , the actual kinematic viscosity at the operating temperature v divided by the reference kinematic viscosity v_1 as shown in the following equation.

A κ greater than 4, equal to 4, or less than 0.1 is not applicable.

For details on lubricants such as grease and lubricants with extreme pressure additives, contact JTEKT.

$$\kappa = \frac{v}{v_1} \dots\dots\dots (5-10)$$

v : Actual kinematic viscosity at the operating temperature; the viscosity of the lubricant at the operating temperature (refer to Fig. 12-3, p. A129)

v_1 : Reference kinematic viscosity; determined according to the speed and pitch diameter of ball/roller set D_{pw} of the bearing (ref. Fig. 5-6)

5. Selection of bearing dimensions

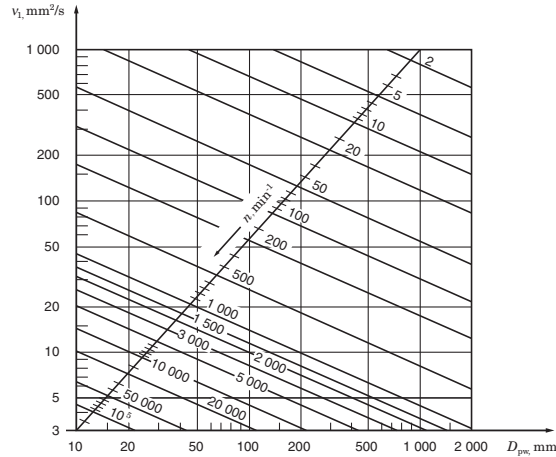

(Fig. 5-6 Citation from JIS B 1518:2013)

Fig. 5-6 Reference kinematic viscosity v_1

5-2-5 Service life of bearing system comprising two or more bearings

Even for systems which comprise two or more bearings, if one bearing is damaged, the entire system malfunctions.

Where all bearings used in an application are regarded as one system, the service life of the bearing system can be calculated using the following equation,

$$\frac{1}{L^e} = \frac{1}{L_1^e} + \frac{1}{L_2^e} + \frac{1}{L_3^e} + \dots \quad (5-11)$$

where :

- L : rating life of system
- L_1, L_2, L_3, \dots : rating life of each bearing
- e : constant

$e = 10/9$ball bearing
 $e = 9/8$roller bearing
 The mean value is for a system using both ball and roller bearings.

[Example]

When a shaft is supported by two roller bearings whose service lives are 50 000 hours and 30 000 hours respectively, the rating life of the bearing system supporting this shaft is calculated as follows, using equation (5-11) :

$$\frac{1}{L^{9/8}} = \frac{1}{50\,000^{9/8}} + \frac{1}{30\,000^{9/8}}$$

$$L \doteq 20\,000 \text{ h}$$

The equation suggests that the rating life of these bearings as a system becomes shorter than that of the bearing with the shorter life.

This fact is very important in estimating bearing service life for applications using two or more bearings.

5-2-6 Applications and recommended bearing service life

Since longer service life does not always contribute to economical operation, the most suitable service life for each application and operating conditions should be determined.

For reference, Table 5-5 describes recommended service life in accordance with the application, as empirically determined.

Table 5-5 Recommended bearing service life (reference)

Operating condition	Application	Recommended service life (h)
Short or intermittent operation	Household electric appliance, electric tools, agricultural equipment, heavy cargo hoisting equipment	4 000 – 8 000
Not extended duration, but stable operation required	Household air conditioner motors, construction equipment, conveyers, elevators	8 000 – 12 000
Intermittent but extended operation	Rolling mill roll necks, small motors, cranes	8 000 – 12 000
	Motors used in factories, general gears	12 000 – 20 000
	Machine tools, shaker screens, crushers	20 000 – 30 000
	Compressors, pumps, gears for essential use	40 000 – 60 000
Daily operation more than 8 hr. or continuous extended operation	Escalators	12 000 – 20 000
	Centrifugal separators, air conditioners, air blowers, woodworking equipment, passenger coach axle journals	20 000 – 30 000
	Large motors, mine hoists, locomotive axle journals, railway rolling stock traction motors	40 000 – 60 000
	Paper manufacturing equipment	100 000 – 200 000
24 hr. operation (no failure allowed)	Water supply facilities, power stations, mine water discharge facilities	100 000 – 200 000

5-3 Calculation of loads

Loads affecting bearings includes force exerted by the weight of the object the bearings support, transmission force of devices such as gears and belts, loads generated in equipment during operation etc.

Seldom can these kinds of load be determined by simple calculation, because the load is not always constant.

In many cases, the load fluctuates, and it is difficult to determine the frequency and magnitude of the fluctuation.

Therefore, loads are normally obtained by multiplying theoretical values with various coefficients obtained empirically.

5-3-1 Load coefficient

Even if radial and axial loads are obtained through general dynamic calculation, the actual load becomes greater than the calculated value due to vibration and impact during operation.

In many cases, the load is obtained by multiplying theoretical values by the load coefficient.

$$F = f_w \cdot F_c \quad \dots\dots\dots (5-12)$$

where :

F : measured load N

F_c : calculated load N

f_w : load coefficient (ref. Table 5-6)

5-3-2 Load generated through belt or chain transmission

In the case of belt transmission, the theoretical value of the load affecting the pulley shafts can be determined by obtaining the effective transmission force of the belt.

For actual operation, the load is obtained by multiplying this effective transmission force by the load coefficient (f_w) considering vibration and impact generated during operation, and the belt coefficient (f_b) considering belt tension.

In the case of chain transmission, the load is determined using a coefficient equivalent to the belt coefficient.

This equation (5-13) is as follows ;

$$F_b = \frac{2M}{D_p} \cdot f_w \cdot f_b$$

$$= \frac{19.1 \times 10^6 W}{D_p n} \cdot f_w \cdot f_b \quad \dots\dots\dots (5-13)$$

where :

F_b : estimated load affecting pulley shaft or sprocket shaft N

M : torque affecting pulley or sprocket mN · m

W : transmission force kW

D_p : pitch circle diameter of pulley or sprocket mm

n : rotational speed min⁻¹

f_w : load coefficient (ref. Table 5-6)

f_b : belt coefficient (ref. Table 5-7)

Table 5-7 Values of belt coefficient f_b

Belt type	f_b
Timing belt (with teeth)	1.3 – 2.0
V-belt	2.0 – 2.5
Flat belt (with tension pulley)	2.5 – 3.0
Flat belt	4.0 – 5.0
Chain	1.2 – 1.5

Table 5-6 Values of load coefficient f_w

Operating condition	Application example	f_w
Operation with little vibration or impact	Motors Machine tools Measuring instrument	1.0 – 1.2
Normal operation (slight impact)	Railway rolling stock Automobiles Paper manufacturing equipment Air blowers Compressors Agricultural equipment	1.2 – 2.0
Operation with severe vibration or impact	Rolling mills Crushers Construction equipment Shaker screens	2.0 – 3.0

5. Selection of bearing dimensions

5-3-3 Load generated under gear transmission

(1) Loads affecting gear and gear coefficient

In the case of gear transmission, loads transmitted by gearing are theoretically classified into three types: tangential load (K_t), radial load (K_r) and axial load (K_a).

Those loads can be calculated dynamically (using equations ㉑, ㉒ and ㉓, described in section (2)).

To determine the actual gear loads, these theoretical loads must be multiplied by coefficients considering vibration and impact during operation (f_w) (ref. Table 5-6) and the gear coefficient (f_g) (ref. Table 5-8) considering the finish treatment of gears.

Table 5-8 Values of gear coefficient f_g

Gear type	f_g
Precision gears (both pitch error and tooth shape error less than 0.02 mm)	1.0 - 1.1
Normal gears (both pitch error and tooth shape error less than 0.1 mm)	1.1 - 1.3

(2) Calculation of load on gears

㉑ Tangential load (tangential force) K_t
(Spur gears, helical gears, double-helical gears, straight bevel gears, spiral bevel gears)
$K_t = \frac{2M}{D_p} = \frac{19.1 \times 10^6 W}{D_p n}$ (5-14)

㉑-㉓ where :

K_t : gear tangential load	N
K_r : gear radial load	N
K_a : gear axial load	N
M : torque affecting gears	mN · m
D_p : gear pitch circle diameter	mm
W : transmitting force	kW
n : rotational speed	min ⁻¹
α : gear pressure angle	deg
β : gear helix (spiral) angle	deg
δ : bevel gear pitch angle	deg

	㉒ Radial load (separating force) K_r	㉓ Axial load (axial force) K_a
Spur gears	$K_r = K_t \tan \alpha$ (5-15)	0
Helical gears	$K_r = K_t \frac{\tan \alpha}{\cos \beta}$ (5-16)	$K_a = K_t \tan \beta$ (5-22)
Double-helical gears	$K_r = K_t \frac{\tan \alpha}{\cos \beta}$ (5-17)	0
Straight ¹⁾ bevel gears	Drive side $K_{r1} = K_t \tan \alpha \cos \delta_1$ (5-18)	$K_{a1} = K_t \tan \alpha \sin \delta_1$ (5-23)
	Driven side $K_{r2} = K_t \tan \alpha \cos \delta_2$ (5-19)	$K_{a2} = K_t \tan \alpha \sin \delta_2$ (5-24)
Spiral ^{1), 2)} bevel gears	Drive side $K_{r1} = \frac{K_t}{\cos \beta} (\tan \alpha \cos \delta_1 \pm \sin \beta \sin \delta_1)$ (5-20)	$K_{a1} = \frac{K_t}{\cos \beta} (\tan \alpha \sin \delta_1 \mp \sin \beta \cos \delta_1)$ (5-25)
	Driven side $K_{r2} = \frac{K_t}{\cos \beta} (\tan \alpha \cos \delta_2 \mp \sin \beta \sin \delta_2)$ (5-21)	$K_{a2} = \frac{K_t}{\cos \beta} (\tan \alpha \sin \delta_2 \pm \sin \beta \cos \delta_2)$ (5-26)

[Notes] 1) Codes with subscript 1 and 2 shown in equations are respectively applicable to drive side gears and driven side gears.

2) Symbols (+) and (-) denote the following ;

{ Symbols in upper row : clockwise rotation accompanied by right-handed spiral or counterclockwise rotation with left-handed spiral
 { Symbols in lower row : counterclockwise rotation with right-handed spiral or clockwise rotation with left-handed spiral

[Remark] Rotating directions are described as viewed at the back of the apex of the pitch angle.

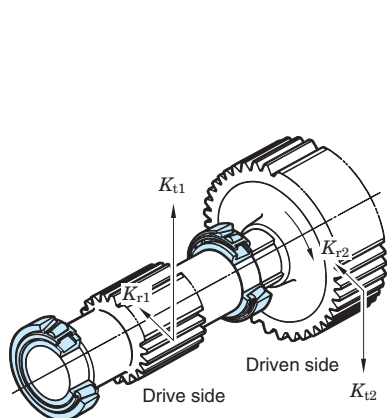

Fig. 5-7 Load on spur gears

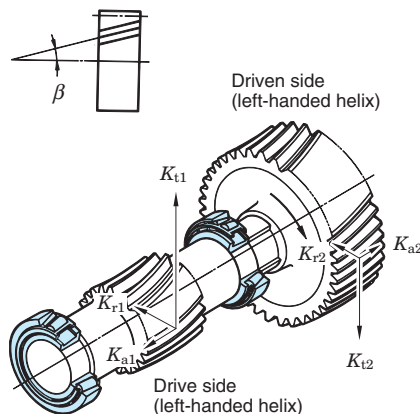

Fig. 5-8 Load on helical gears

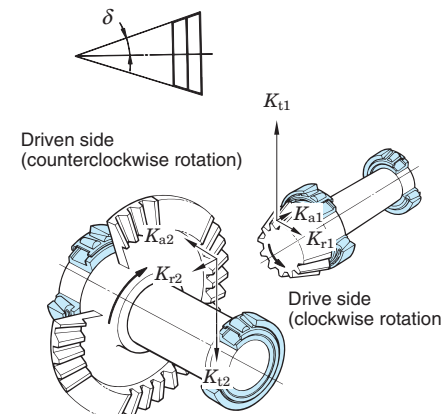

Fig. 5-9 Load on straight bevel gears

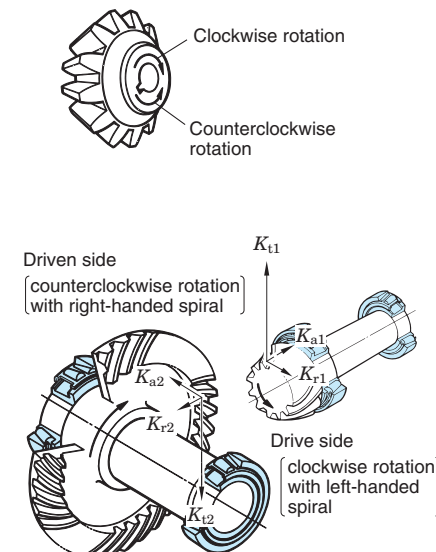

Fig. 5-10 Load on spiral bevel gears

5-4 Dynamic equivalent load

Bearings are used under various operating conditions; however, in most cases, bearings receive radial and axial load combined, while the load magnitude fluctuates during operation.

Therefore, it is impossible to directly compare the actual load and basic dynamic load rating.

The two are compared by replacing the loads applied to the shaft center with one of a constant magnitude and in a specific direction, that yields the same bearing service life as under actual load and rotational speed.

This theoretical load is referred to as the dynamic equivalent load (P).

5-4-1 Calculation of dynamic equivalent load

Dynamic equivalent loads for radial bearings and thrust bearings ($\alpha \neq 90^\circ$) which receive a combined load of a constant magnitude in a specific direction can be calculated using the following equation,

$$P = XF_r + YF_a \quad (5-32)$$

where :

- P : dynamic equivalent load N
- F_r : radial load N
- F_a : axial load N
- X : radial load factor
- Y : axial load factor

(values of X and Y are listed in the bearing specification table.)

- When $F_a/F_r \leq e$ for single-row radial bearings, it is taken that $X = 1$, and $Y = 0$. Hence, the dynamic equivalent load rating is $P_r = F_r$.

(Values of e , which designates the limit of F_a/F_r , are listed in the bearing specification table.)

- For single-row angular contact ball bearings and tapered roller bearings, axial component forces (F_{ac}) are generated as shown in Fig. 5-11, therefore a pair of bearings is arranged face-to-face or back-to-back.

The axial component force can be calculated using the following equation.

$$F_{ac} = \frac{F_r}{2Y} \quad (5-33)$$

Table 5-9 describes the calculation of the dynamic equivalent load when radial loads and external axial loads (K_a) are applied to bearings.

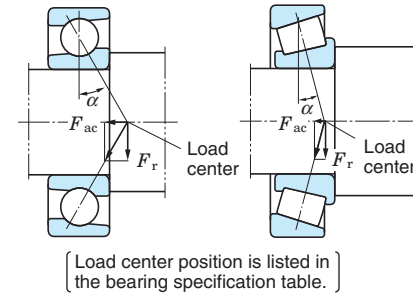

Fig. 5-11 Axial component force

- For thrust ball bearings with contact angle $\alpha = 90^\circ$, to which an axial load is applied, $P_a = F_a$.

- The dynamic equivalent load of spherical thrust roller bearing can be calculated using the following equation.

$$P_a = F_a + 1.2F_r \quad (5-34)$$

where : $F_r/F_a \leq 0.55$

Table 5-9 Dynamic equivalent load calculation : when a pair of single-row angular contact ball bearings or tapered roller bearings is arranged face-to-face or back-to-back.

Paired mounting		Loading condition	Bearing	Axial load	Dynamic equivalent load
Back-to-back arrangement	Face-to-face arrangement				
		$\frac{F_{rB}}{2Y_B} + K_a \geq \frac{F_{rA}}{2Y_A}$	Bearing A	$\frac{F_{rB}}{2Y_B} + K_a$	$P_A = XF_{rA} + Y_A \left(\frac{F_{rB}}{2Y_B} + K_a \right)$ $P_A = F_{rA}$, where $P_A < F_{rA}$
			Bearing B	-	$P_B = F_{rB}$
		$\frac{F_{rB}}{2Y_B} + K_a < \frac{F_{rA}}{2Y_A}$	Bearing A	-	$P_A = F_{rA}$
			Bearing B	$\frac{F_{rA}}{2Y_A} - K_a$	$P_B = XF_{rB} + Y_B \left(\frac{F_{rA}}{2Y_A} - K_a \right)$ $P_B = F_{rB}$, where $P_B < F_{rB}$
		$\frac{F_{rB}}{2Y_B} \leq \frac{F_{rA}}{2Y_A} + K_a$	Bearing A	-	$P_A = F_{rA}$
			Bearing B	$\frac{F_{rA}}{2Y_A} + K_a$	$P_B = XF_{rB} + Y_B \left(\frac{F_{rA}}{2Y_A} + K_a \right)$ $P_B = F_{rB}$, where $P_B < F_{rB}$
		$\frac{F_{rB}}{2Y_B} > \frac{F_{rA}}{2Y_A} + K_a$	Bearing A	$\frac{F_{rB}}{2Y_B} - K_a$	$P_A = XF_{rA} + Y_A \left(\frac{F_{rB}}{2Y_B} - K_a \right)$ $P_A = F_{rA}$, where $P_A < F_{rA}$
			Bearing B	-	$P_B = F_{rB}$

[Remarks] 1. These equations can be used when internal clearance and preload during operation are zero.
2. Radial load is treated as positive in the calculation, if it is applied in a direction opposite that shown in Fig. in Table 5-9.

5. Selection of bearing dimensions

5-4-2 Mean dynamic equivalent load

When load magnitude or direction varies, it is necessary to calculate the mean dynamic equivalent load, which provides the same length of bearing service life as that under the actual load fluctuation.

The mean dynamic equivalent load (P_m) under different load fluctuations is described using Graphs (1) to (4).

As shown in Graph (5), the mean dynamic equivalent load under stationary and rotating load applied simultaneously, can be obtained using equation (5-39).

(1) Staged fluctuation	(2) Stageless fluctuation	(3) Fluctuation forming sine curve	(4) Fluctuation forming sine curve (upper half of sine curve)
$P_m = \sqrt[p]{\frac{P_1^p n_1 t_1 + P_2^p n_2 t_2 + \dots + P_n^p n_n t_n}{n_1 t_1 + n_2 t_2 + \dots + n_n t_n}} \dots (5-35)$	$P_m = \frac{P_{\min} + 2 P_{\max}}{3} \dots (5-36)$	$P_m = 0.68 P_{\max} \dots (5-37)$	$P_m = 0.75 P_{\max} \dots (5-38)$

Symbols for Graphs (1) to (4)

P_m	: mean dynamic equivalent load	N
P_1	: dynamic equivalent load applied for t_1 hours at rotational speed n_1	N
P_2	: dynamic equivalent load applied for t_2 hours at rotational speed n_2	N
\vdots	\vdots	\vdots
P_n	: dynamic equivalent load applied for t_n hours at rotational speed n_n	N
P_{\min}	: minimum dynamic equivalent load	N
P_{\max}	: maximum dynamic equivalent load	N
$\Sigma n_i t_i$: total rotation in (t_1 to t_i) hours	
p	: for ball bearings, $p = 3$ for roller bearings, $p = 10/3$	

[Reference] Mean rotational speed n_m can be calculated using the following equation :

$$n_m = \frac{n_1 t_1 + n_2 t_2 + \dots + n_n t_n}{t_1 + t_2 + \dots + t_n}$$

(5) Stationary load and rotating load acting simultaneously

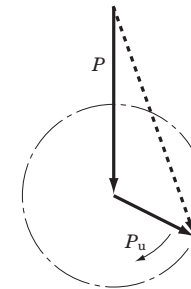

$$P_m = f_m (P + P_u) \dots (5-39)$$

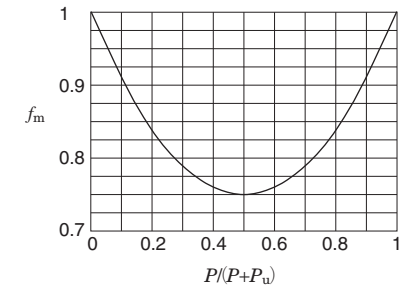

Fig. 5-12 Coefficient f_m

where :

P_m	: mean dynamic equivalent load	N
f_m	: coefficient (refer. Fig. 5-12)	
P	: stationary load	N
P_u	: rotating load	N

5-5 Basic static load rating and static equivalent load

5-5-1 Basic static load rating

Excessive static load or impact load even at very low rotation causes partial permanent deformation of the rolling element and raceway contacting surfaces. This permanent deformation increases with the load; if it exceeds a certain limit, smooth rotation will be hindered.

The basic static load rating is the static load which responds to the calculated contact stress shown below, at the contact center between the raceway and rolling elements which receive the maximum load.

- Self-aligning ball bearings ... 4 600 MPa
- Other ball bearings 4 200 MPa
- Roller bearings 4 000 MPa

The total extent of contact stress-caused permanent deformation on surfaces of rolling elements and raceway will be approximately 0.000 1 times greater than the rolling element diameter.

The basic static load rating for radial bearings is specified as the basic static radial load rating, and for thrust bearings, as the basic static axial load rating. These load ratings are listed in the bearing specification table, using C_{0r} and C_{0a} respectively.

These values are prescribed by ISO 78/1987 and are subject to change by conformance to the latest ISO standards.

5-5-2 Static equivalent load

The static equivalent load is a theoretical load calculated such that, during rotation at very low speed or when bearings are stationary, the same contact stress as that imposed under actual loading condition is generated at the contact center between raceway and rolling element to which the maximum load is applied.

For radial bearings, radial load passing through the bearing center is used for the calculation; for thrust bearings, axial load in a direction along the bearing axis is used.

The static equivalent load can be calculated using the following equations.

[Radial bearings]

...The greater value obtained by the following two equations is used.

$$P_{0r} = X_0 F_r + Y_0 F_a \quad (5-40)$$

$$P_{0r} = F_r \quad (5-41)$$

[Thrust bearings]

($\alpha \neq 90^\circ$)

$$P_{0a} = X_0 F_r + F_a \quad (5-42)$$

[When $F_a < X_0 F_r$, the solution becomes less accurate.]

($\alpha = 90^\circ$)

$$P_{0a} = F_a \quad (5-43)$$

where :

P_{0r} : static equivalent radial load N

P_{0a} : static equivalent axial load N

F_r : radial load N

F_a : axial load N

X_0 : static radial load factor

Y_0 : static axial load factor

(values of X_0 and Y_0 are listed in the bearing specification table.)

5-5-3 Safety coefficient

The allowable static equivalent load for a bearing is determined by the basic static load rating of the bearing; however, bearing service life, which is affected by permanent deformation, differs in accordance with the performance required of the bearing and operating conditions.

Therefore, a safety coefficient is designated, based on empirical data, so as to ensure safety in relation to basic static load rating.

$$f_s = \frac{C_0}{P_0} \quad (5-44)$$

where :

f_s : safety coefficient (ref. Table 5-10)

C_0 : basic static load rating N

P_0 : static equivalent load N

Table 5-10 Values of safety coefficient f_s

Operating condition	f_s (min.)		
	Ball bearing	Roller bearing	
With bearing rotation	When high accuracy is required	2	3
	Normal operation	1	1.5
	When impact load is applied	1.5	3
Without bearing rotation (occasional oscillation)	Normal operation	0.5	1
	When impact load or uneven distribution load is applied	1	2

[Remark] For spherical thrust roller bearings, $f_s \geq 4$.

5-6 Allowable axial load for cylindrical roller bearings

Bearings whose inner and outer rings comprise either a rib or loose rib can accommodate a certain magnitude of axial load, as well as radial load. In such cases, axial load capacity is controlled by the condition of rollers, load capacity of rib or loose rib, lubrication, rotational speed etc.

For certain special uses, a design is available to accommodate very heavy axial loads. In general, axial loads allowable for cylindrical roller bearings can be calculated using the following equation, which are based on empirical data.

$$F_{ap} = 9.8 f_a \cdot f_b \cdot f_p \cdot d_m^2 \dots\dots\dots (5-45)$$

where :

F_{ap} : maximum allowable axial load N

f_a : coefficient determined from loading condition (Table 5-11)

f_b : coefficient determined from bearing diameter series (Table 5-12)

f_p : coefficient for rib surface pressure (Fig. 5-13)

d_m : mean value of bore diameter d and outside diameter D mm

$$\left(\frac{d + D}{2} \right)$$

Table 5-11 Values of coefficient determined from loading condition f_a

Loading condition	f_a
Continuous loading	1
Intermittent loading	2
Instantaneous loading	3

Table 5-12 Values of coefficient determined from bearing diameter series f_b

Diameter series	f_b
9	0.6
0	0.7
2	0.8
3	1.0
4	1.2

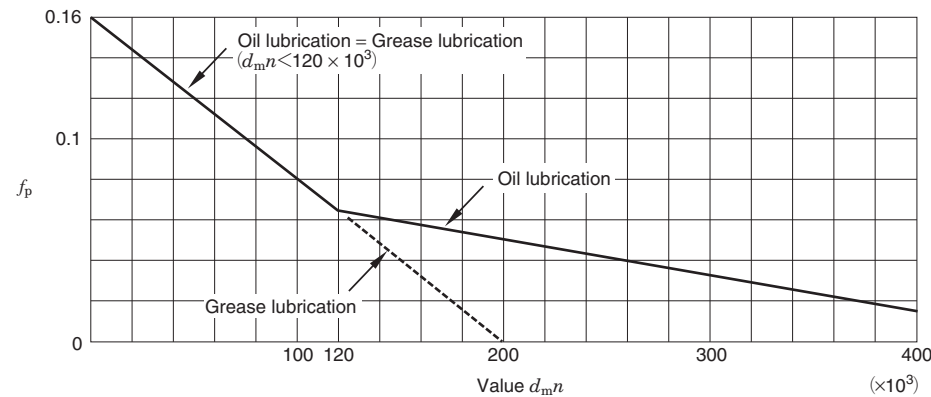
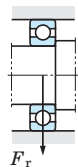
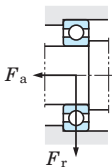

Fig. 5-13 Relationship between coefficient for rib surface pressure f_p and value $d_m n$ (n : rotational speed, min^{-1})

5-7 Applied calculation examples

[Example 1] Bearing service life (time) with 90 % reliability	[Example 2] Bearing service life (time) with 96 % reliability
<p>(Conditions)</p> <p>Deep groove ball bearing : 6308</p> <p>Radial load $F_r = 3\,500\text{ N}$</p> <p>Axial load not applied ($F_a = 0$)</p> <p>Rotational speed $n = 800\text{ min}^{-1}$</p> 	<p>(Conditions)</p> <p>Deep groove ball bearing : 6308</p> <p>Radial load $F_r = 3\,500\text{ N}$</p> <p>Axial load $F_a = 1\,000\text{ N}$</p> <p>Rotational speed $n = 800\text{ min}^{-1}$</p> 
<p>① Basic dynamic load rating (C_r) is obtained from the bearing specification table.</p> <p>$C_r = 50.9\text{ kN}$</p> <p>② Dynamic equivalent radial load (P_r) is calculated using equation (5-32).</p> <p>$P_r = F_r = 3\,500\text{ N}$</p> <p>③ Bearing service life (L_{10h}) is calculated using equation (5-2).</p> $L_{10h} = \frac{10^6}{60n} \left(\frac{C}{P} \right)^p$ $= \frac{10^6}{60 \times 800} \times \left(\frac{50.9 \times 10^3}{3\,500} \right)^3 \doteq \underline{64\,100\text{ h}}$	<p>① From the bearing specification table ;</p> <ul style="list-style-type: none"> Basic load rating (C_r, C_{0r}) f_0 factor is obtained. $C_r = 50.9\text{ kN}$ $C_{0r} = 24.0\text{ kN}$ $f_0 = 13.2$ Values X and Y are obtained by comparing value e, calculated from value $f_0 F_a / C_{0r}$ via proportional interpolation, with value $f_0 F_a / F_r$. $\frac{f_0 F_a}{C_{0r}} = \frac{13.2 \times 1\,000}{24.0 \times 10^3} = 0.550$ $e = 0.22 + (0.26 - 0.22) \times \frac{(0.550 - 0.345)}{(0.689 - 0.345)}$ $= 0.24$ $\frac{F_a}{F_r} = \frac{1\,000}{3\,500} = 0.29 > e$ <p>The result is,</p> <p>$X = 0.56$</p> <p>$Y = 1.99 - (1.99 - 1.71) \times \frac{(0.550 - 0.345)}{(0.689 - 0.345)}$</p> $= 1.82$ <p>② Dynamic equivalent load (P_r) is obtained using equation (5-32).</p> $P_r = XF_r + YF_a$ $= (0.56 \times 3\,500) + (1.82 \times 1\,000) = 3\,780\text{ N}$ <p>③ Service life with 90 % reliability (L_{10h}) is obtained using equation (5-2).</p> $L_{10h} = \frac{10^6}{60n} \left(\frac{C}{P} \right)^p$ $= \frac{10^6}{60 \times 800} \times \left(\frac{50.9 \times 10^3}{3\,780} \right)^3 \doteq \underline{50\,900\text{ h}}$

[Example 3] Calculation of the a_{ISO} factor with the conditions in Example 2
<p>(Conditions)</p> <p>Oil lubrication</p> <p>(Oil that has been filtered by a fine filter)</p> <p>Operating temperature $70\text{ }^\circ\text{C}$</p> <p>96 % reliability</p>
<p>④ Lubricating oil selection</p> <p>From the bearing specification table, the pitch diameter $D_{pw} = (40 + 90)/2 = 65$ is obtained.</p> <p>$d_{mn} = 65 \times 800 = 52\,000$. Therefore, select VG 68 from Table 12-8, p. A 129.</p> <p>⑤ Calculating the a_{ISO} factor</p> <p>The operating temperature is $70\text{ }^\circ\text{C}$, so according to Fig. 12-3, p. A 129, the viscosity when operating is $v = 20\text{ mm}^2/\text{s}$</p> <p>According to Fig. A, $v_1 = 21.7\text{ mm}^2/\text{s}$</p> <p>$\kappa = v/v_1 = 20/21.7 = 0.92$</p> <p>The oil has been filtered by a fine filter, so Table 5-4 shows e_c is 0.5 to 0.6.</p> <p>To stringently estimate the value, $e_c = 0.5$.</p> $\frac{e_c \cdot C_u}{P} = \frac{0.5 \times 1\,850}{3\,780} = 0.24$ <p>Therefore, according to Fig. B</p> <p>$a_{ISO} = 7.7$</p> <p>⑥ Service life with 96 % reliability (L_{nm}) is obtained using equation (5-8).</p> <p>According to Table 5-3, $a_1 = 0.55$.</p> $L_{4m} = a_1 a_{ISO} L_{10} = 0.55 \times 7.7 \times 50\,900 \doteq \underline{216\,000\text{ h}}$

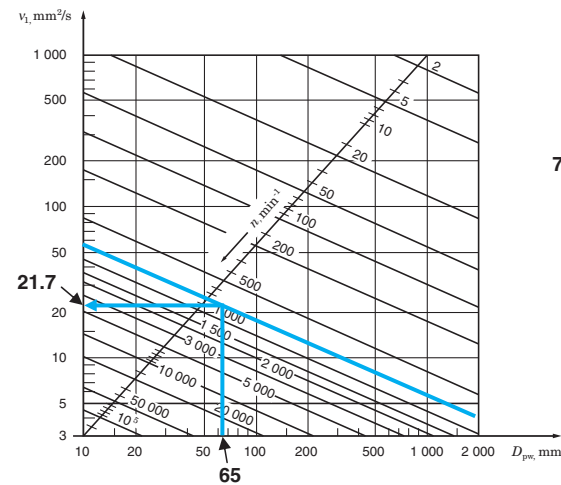

Fig. A

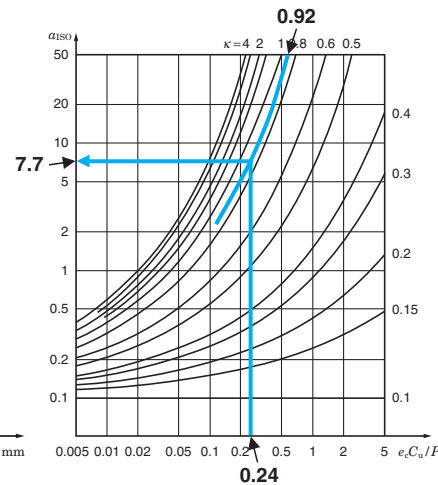
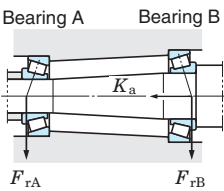

Fig. B

The a_{ISO} factor can also be calculated on our website.

[Example 4] Bearing service life (total revolution)

(Conditions)
 Tapered roller bearing
 Bearing A : 30207 JR
 Bearing B : 30209 JR
 Radial load $F_{rA} = 5\,200\text{ N}$
 $F_{rB} = 6\,800\text{ N}$
 Axial load $K_a = 1\,600\text{ N}$



① From the bearing specification table, the following specifications are obtained.

	Basic dynamic load rating (C_r)	e	$X^{1)}$	$Y^{1)}$
Bearing A	68.8 kN	0.37	0.4	1.60
Bearing B	83.9 kN	0.40	0.4	1.48

[Note] 1) Those values are used, where $F_a/F_r > e$.
 Where $F_a/F_r \leq e$, $X = 1$, $Y = 0$.

② Axial load applied to shafts must be calculated, considering the fact that component force in the axial direction is generated when radial load is applied to tapered roller bearings. (ref. equation 5-33, Table 5-9)

$$\frac{F_{rA}}{2 Y_A} + K_a = \frac{5\,200}{2 \times 1.60} + 1\,600 = 3\,225\text{ N}$$

$$\frac{F_{rB}}{2 Y_B} = \frac{6\,800}{2 \times 1.48} = 2\,297\text{ N}$$

Consequently, axial load $\frac{F_{rA}}{2 Y_A} + K_a$ is applied to bearing B.

③ Dynamic equivalent load (P_r) is obtained from Table 5-9.

$$P_{rA} = F_{rA} = 5\,200\text{ N}$$

$$P_{rB} = X F_{rB} + Y_B \left(\frac{F_{rA}}{2 Y_A} + K_a \right)$$

$$= 0.4 \times 6\,800 + 1.48 \times 3\,225 = 7\,493\text{ N}$$

④ Each bearing service life (L_{10}) is calculated using equation (5-1).

$$L_{10A} = \left(\frac{C_{rA}}{P_{rA}} \right)^{10/3} = \left(\frac{68.8 \times 10^3}{5\,200} \right)^{10/3}$$

$$\doteq 5\,480 \times 10^6 \text{ revolutions}$$

$$L_{10B} = \left(\frac{C_{rB}}{P_{rB}} \right)^{10/3} = \left(\frac{83.9 \times 10^3}{7\,493} \right)^{10/3}$$

$$\doteq 3\,140 \times 10^6 \text{ revolutions}$$

[Example 5] Bearing size selection

(Conditions)
 Deep groove ball bearing :
 62 series
 Required service life :
 more than 10 000 h
 Radial load $F_r = 2\,000\text{ N}$
 Axial load $F_a = 300\text{ N}$
 Rotational speed $n = 1\,600\text{ min}^{-1}$

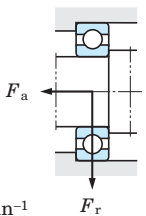

① The dynamic equivalent load (P_r) is hypothetically calculated.

The resultant value, $F_a/F_r = 300/2\,000 = 0.15$, is smaller than any other values of e in the bearing specification table.

Hence, JTEKT can consider that $P_r = F_r = 2\,000\text{ N}$.

② The required basic dynamic load rating (C_r) is calculated according to equation (5-4).

$$C_r = P_r \left(L_{10h} \times \frac{60n}{10^6} \right)^{1/p}$$

$$= 2\,000 \times \left(10\,000 \times \frac{60 \times 1\,600}{10^6} \right)^{1/3}$$

$$= 19\,730\text{ N}$$

③ Among those covered by the bearing specification table, the bearing of the 62 series with C_r exceeding 19 730 N is 6205 R, with bore diameter for 25 mm.

④ The dynamic equivalent load obtained at step ① is confirmed by obtaining value e for 6205 R.

Where C_{0r} of 6205 R is 9.3 kN, and f_0 is 12.8

$$f_0 F_a / C_{0r} = 12.8 \times 300 / 9\,300 = 0.413$$

Then, value e can be calculated using proportional interpolation.

$$e = 0.22 + (0.26 - 0.22) \times \frac{(0.413 - 0.345)}{(0.689 - 0.345)}$$

$$= 0.23$$

As a result, it can be confirmed that

$$F_a / F_r = 0.15 < e.$$

Hence, $P_r = F_r$.

[Example 6] Bearing size selection

(Conditions)
 Deep groove ball bearing :
 63 series
 Required service life :
 more than 15 000 h
 Radial load $F_r = 4\,000\text{ N}$
 Axial load $F_a = 2\,400\text{ N}$
 Rotational speed $n = 1\,000\text{ min}^{-1}$

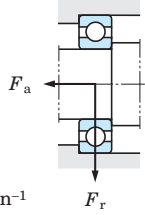

① The hypothetical dynamic equivalent load (P_r) is calculated :

Since $F_a/F_r = 2\,400/4\,000 = 0.6$ is much larger than the value e specified in the bearing specification table, it suggests that the axial load affects the dynamic equivalent load.

Hence, assuming that $X = 0.56$, $Y = 1.6$ (approximate mean value of Y), using equation (5-32),

$$P_r = X F_r + Y F_a = 0.56 \times 4\,000 + 1.6 \times 2\,400$$

$$= 6\,080\text{ N}$$

② Using equation (5-4), the required basic dynamic load rating (C_r) is :

$$C_r = P_r \left(L_{10h} \times \frac{60n}{10^6} \right)^{1/p}$$

$$= 6\,080 \times \left(15\,000 \times \frac{60 \times 1\,000}{10^6} \right)^{1/3}$$

$$= 58\,700\text{ N}$$

③ From the bearing specification table, a 6309 with a bore diameter of 45 mm is selected as a 63 series bearing with C_r exceeding 58 700 N.

④ The dynamic equivalent load and basic rating life are confirmed, by calculating the value e for a 6309.

Values obtained using the proportional interpolation are :

where $f_0 F_a / C_{0r} = 13.3 \times 2\,400 / 29\,500 = 1.082$
 $e = 0.283$, $Y = 1.54$.
 Thus, $F_a/F_r = 0.6 > e$.

Using the resultant values, the dynamic equivalent load and basic rating life can be calculated as follows :

$$P_r = X F_r + Y F_a$$

$$= 0.56 \times 4\,000 + 1.54 \times 2\,400 = 5\,940\text{ N}$$

$$L_{10h} = \frac{10^6}{60n} \left(\frac{C_r}{P_r} \right)^p$$

$$= \frac{10^6}{60 \times 1\,000} \times \left(\frac{61.1 \times 10^3}{5\,940} \right)^3 \doteq 18\,100\text{ h}$$

⑤ The basic rating life of the 6308, using the same steps, is :

$$L_{10h} \doteq 11\,500\text{ h}, \text{ which does not satisfy the service life requirement.}$$

[Example 7] Calculation of allowable axial load for cylindrical roller bearings

(Conditions)
 Single-row cylindrical roller bearing : NUP 310
 Rotational speed $n = 1\,500\text{ min}^{-1}$
 Oil lubrication
 Axial load is intermittently applied.

① Using the bearing specification table, the value d_m for the NUP 310 can be calculated as follows :

$$d_m = \frac{d + D}{2} = \frac{50 + 110}{2} = 80\text{ mm}$$

② Each coefficient used in equation (5-45).
 From values listed in Table 5-11, coefficient f_a related to intermittent load is : $f_a = 2$

From values listed in Table 5-12, coefficient f_b related to diameter series 3 is : $f_b = 1.0$

According to Fig. 5-13, coefficient f_p for allowable rib surface pressure, related to

$$d_m n = 80 \times 1\,500 = 12 \times 10^4, \text{ is : } f_p = 0.062$$

③ Using equation (5-45), the allowable axial load F_{ap} is :

$$F_{ap} = 9.8 f_a \cdot f_b \cdot f_p \cdot d_m^2$$

$$= 9.8 \times 2 \times 1.0 \times 0.062 \times 80^2$$

$$\doteq 7\,780\text{ N}$$

5. Selection of bearing dimensions

[Example 8] Calculation of service life of spur gear shaft bearings

(Conditions)

Tapered roller bearing

Bearing A : 32309 JR

Bearing B : 32310 JR

Gear type : spur gear (normally machined)

Gear pressure angle $\alpha_1 = \alpha_2 = 20^\circ$

Gear pitch circle diameter $D_{p1} = 360$ mm

$D_{p2} = 180$ mm

Transmission power $W = 150$ kW

Rotational speed $n = 1\ 000$ min⁻¹

Operating condition: accompanied by impact

Installation locations

$a_1 = 95$ mm, $a_2 = 265$ mm,

$b_1 = 245$ mm, $b_2 = 115$ mm,

$c = 360$ mm

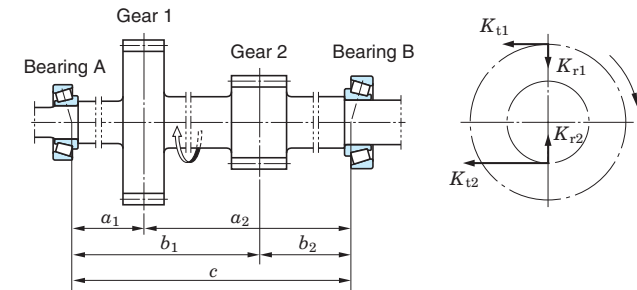

① Using equations (5-14) and (5-15), theoretical loads applied to gears (tangential load, K_t ; radial load, K_r) are calculated.

[Gear 1]

$$K_{t1} = \frac{19.1 \times 10^6 W}{D_p n} = \frac{19.1 \times 10^6 \times 150}{360 \times 1\ 000} = 7\ 958\ \text{N}$$

$$K_{r1} = K_{t1} \tan \alpha_1 = 2\ 896\ \text{N}$$

[Gear 2]

$$K_{t2} = \frac{19.1 \times 10^6 \times 150}{180 \times 1\ 000} = 15\ 917\ \text{N}$$

$$K_{r2} = K_{t2} \tan \alpha_2 = 5\ 793\ \text{N}$$

② The radial load applied to the bearing is calculated, where the load coefficient is determined as $f_w = 1.5$ from Table 5-6, and the gear coefficient as $f_g = 1.2$ from Table 5-8.

[Bearing A]

• Load consisting of K_{t1} and K_{t2} is :

$$K_{tA} = f_w f_g \left(\frac{a_2}{c} K_{t1} + \frac{b_2}{c} K_{t2} \right) = 1.5 \times 1.2 \times \left(\frac{265}{360} \times 7\ 958 + \frac{115}{360} \times 15\ 917 \right) = 19\ 697\ \text{N}$$

• Load consisting of K_{r1} and K_{r2} is :

$$K_{rA} = f_w f_g \left(\frac{a_2}{c} K_{r1} - \frac{b_2}{c} K_{r2} \right) = 1.5 \times 1.2 \times \left(\frac{265}{360} \times 2\ 896 - \frac{115}{360} \times 5\ 793 \right) = 506\ \text{N}$$

• Combining the loads of K_{tA} and K_{rA} , the radial load (F_{rA}) applied to bearing A can be calculated as follows :

$$F_{rA} = \sqrt{K_{tA}^2 + K_{rA}^2} = \sqrt{19\ 697^2 + 506^2} = 19\ 703\ \text{N}$$

[Bearing B]

• Load consisting of K_{t1} and K_{t2} is :

$$K_{tB} = f_w f_g \left(\frac{a_1}{c} K_{t1} + \frac{b_1}{c} K_{t2} \right) = 1.5 \times 1.2 \times \left(\frac{95}{360} \times 7\ 958 + \frac{245}{360} \times 15\ 917 \right) = 23\ 278\ \text{N}$$

• Load consisting of K_{r1} and K_{r2} is :

$$K_{rB} = f_w f_g \left(\frac{a_1}{c} K_{r1} - \frac{b_1}{c} K_{r2} \right) = 1.5 \times 1.2 \times \left(\frac{95}{360} \times 2\ 896 - \frac{245}{360} \times 5\ 793 \right) = -5\ 721\ \text{N}$$

• The radial load (F_{rB}) applied to bearing B can be calculated using the same steps as with bearing A.

$$F_{rB} = \sqrt{K_{tB}^2 + K_{rB}^2} = \sqrt{23\ 278^2 + (-5\ 721)^2} = 23\ 971\ \text{N}$$

③ The following specifications can be obtained from the bearing specification table.

	Basic dynamic load rating (C_r)	e	$X^{(1)}$	$Y^{(1)}$
Bearing A	183 kN	0.35	0.4	1.74
Bearing B	221 kN			

[Note] 1) Those values are used, where $F_a/F_r > e$. Where $F_a/F_r \leq e$, $X = 1$, $Y = 0$.

④ When an axial load is not applied externally, if the radial load is applied to the tapered roller bearing, an axial component force is generated.

Considering this fact, the axial load applied from the shaft and peripheral parts is to be calculated :

(Equation 5-33, Table 5-9)

$$\frac{F_{rB}}{2 Y_B} = \frac{23\ 971}{2 \times 1.74} > \frac{F_{rA}}{2 Y_A} = \frac{19\ 703}{2 \times 1.74}$$

According to the result, it is clear that the axial component force ($F_{rB}/2Y_B$) applied to bearing B is also applied to bearing A as an axial load applied from the shaft and peripheral parts.

⑤ Using the values listed in Table 5-9, the dynamic equivalent load is calculated, where $K_a = 0$:

$$P_{rA} = X F_{rA} + Y_A \frac{F_{rB}}{2 Y_B} = 0.4 \times 19\ 703 + 1.74 \times \frac{23\ 971}{2 \times 1.74} = 19\ 867\ \text{N}$$

$$P_{rB} = F_{rB} = 23\ 971\ \text{N}$$

⑥ Using equation (5-2), the basic rating life of each bearing is calculated :

[Bearing A]

$$L_{10hA} = \frac{10^6}{60n} \left(\frac{C_{rA}}{P_A} \right)^p = \frac{10^6}{60 \times 1\ 000} \times \left(\frac{183 \times 10^3}{19\ 867} \right)^{10/3} \approx 27\ 300\ \text{h}$$

[Bearing B]

$$L_{10hB} = \frac{10^6}{60n} \left(\frac{C_{rB}}{P_B} \right)^p = \frac{10^6}{60 \times 1\ 000} \times \left(\frac{221 \times 10^3}{23\ 971} \right)^{10/3} \approx 27\ 400\ \text{h}$$

Reference

Using equation (5-11), the system service life (L_{10hs}) using a pair of bearings is :

$$L_{10hs} = \frac{1}{\left(\frac{1}{L_{10hA}^e} + \frac{1}{L_{10hB}^e} \right)^{1/e}} = \frac{1}{\left(\frac{1}{27\ 300^{9/8}} + \frac{1}{27\ 400^{9/8}} \right)^{8/9}} \approx 14\ 800\ \text{h}$$

6. Boundary dimensions and bearing numbers

6-1 Boundary dimensions

Bearing boundary dimensions are dimensions required for bearing installation with shaft or housing, and as described in Fig. 6-1, include the bore diameter, outside diameter, width, height, and chamfer dimension.

These dimensions are standardized by the International Organization for Standardization (ISO 15). JIS B 1512 "rolling bearing boundary dimensions" is based on ISO.

These boundary dimensions are provided, classified into radial bearings (tapered roller bearings are provided in other tables) and thrust bearings.

Boundary dimensions of each bearing are listed in Appendixes at the back of this catalog. In these boundary dimension tables, the outside diameter, width, height, and chamfer dimen-

sions related to bearing bore diameter numbers and bore diameters are listed in diameter series and dimension series.

Reference

- 1) Diameter series is a series of nominal bearing outside diameters provided for respective ranges of bearing bore diameter; and, a dimension series includes width and height as well as diameters.
- 2) Tapered roller bearing boundary dimensions listed in the Appendixes are adapted to conventional dimension series (widths and diameters). Tapered roller bearing boundary dimensions provided in JIS B 1512-2000 are new dimension series based on ISO 355 (ref. descriptions before the bearing specification table); for reference, the bearing specification table covers numeric codes used in these dimension series.

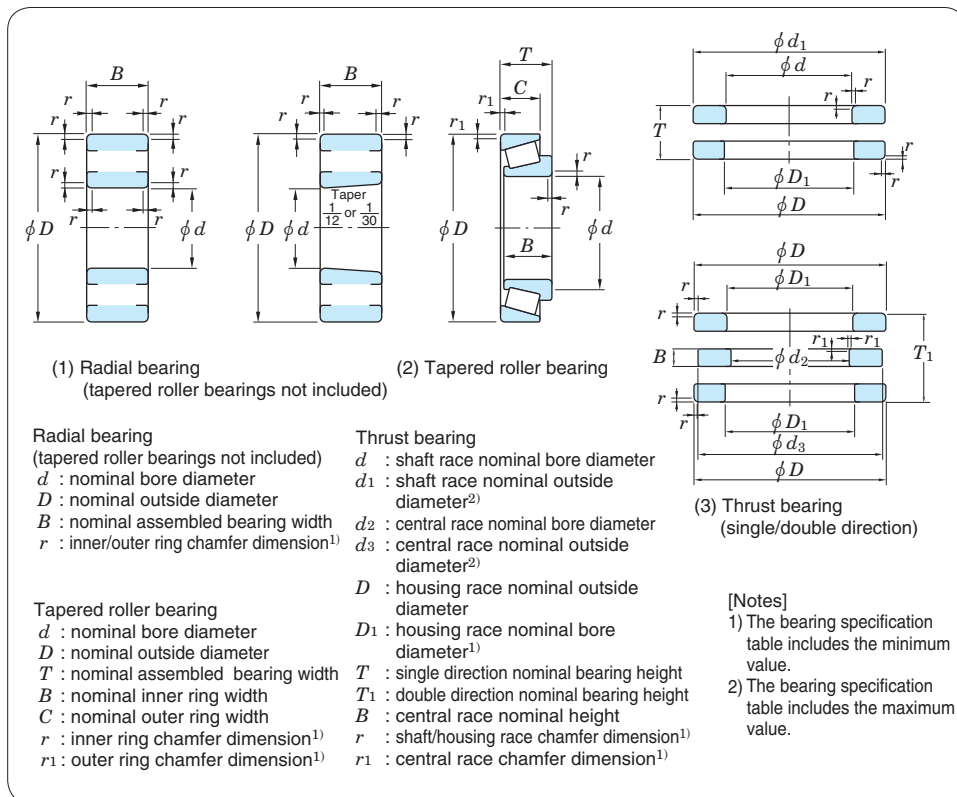

Fig. 6-1 Bearing boundary dimensions

Cross-section dimensions of radial bearings and thrust bearings expressed in dimension series can be compared using Figs. 6-2 and 6-3.

In this way, many dimension series are provided; however, not all dimensions are practically adapted.

Some of them were merely prescribed, given expected future use.

6-2 Dimensions of snap ring grooves and locating snap rings

JIS B 1509 "rolling bearing -radial bearing with locating snap ring-dimensions and tolerances" conforms to the dimensions of snap ring groove for fitting locating snap ring on the outside surface of bearing and the dimensions and tolerances of locating snap ring.

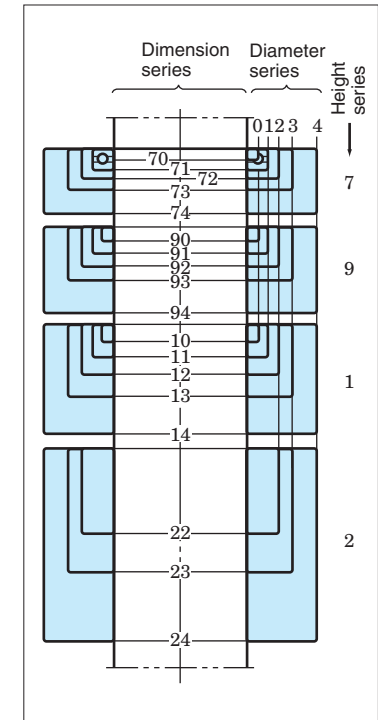

Fig. 6-3 Thrust bearing dimension series diagram (diameter series 5 omitted)

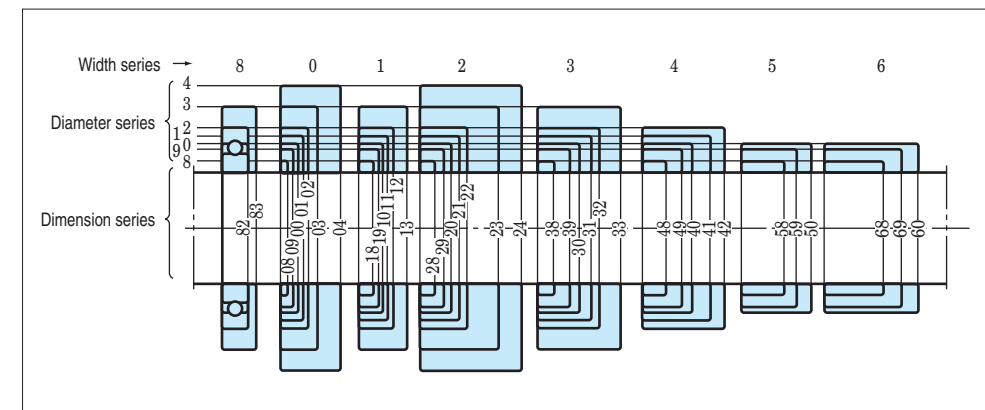

Fig. 6-2 Radial bearing dimension series diagram (diameter series 7 omitted)

6-3 Bearing number

A bearing number is composed of a basic number and a supplementary code, denoting bearing specifications including bearing type, boundary dimensions, running accuracy, and internal clearance.

Bearing numbers of standard bearings corresponding to JIS B 1512 "rolling bearing boundary dimensions" are prescribed in JIS B 1513.

As well as these bearing numbers, JTEKT uses supplementary codes other than those provided by JIS.

Among basic numbers, bearing series codes are listed in Table 6-1, and the composition of bearing numbers is described in Table 6-2, showing the order of arrangement of the parts.

[Examples of bearing numbers]

(Ex. 1)

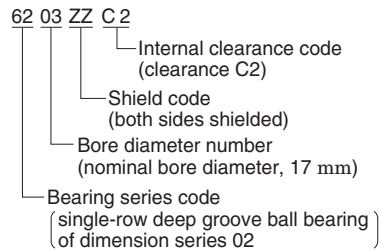

(Ex. 2)

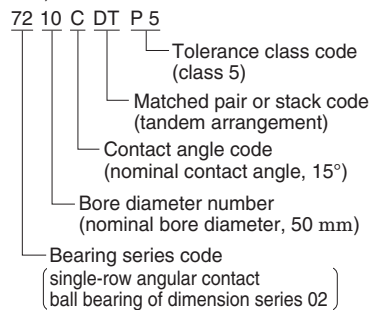

(Ex. 3)

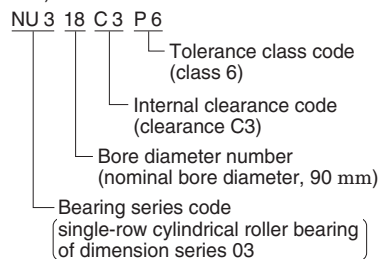

(Ex. 4)

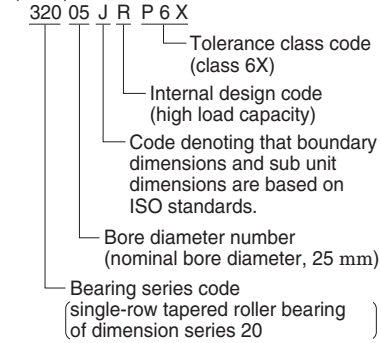

(Ex. 5)

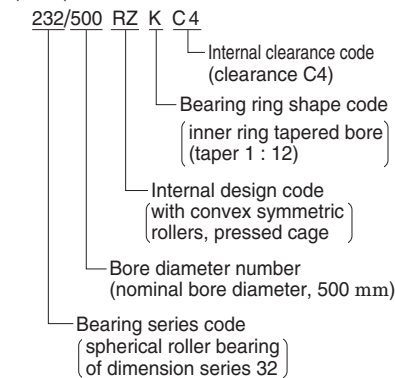

(Ex. 6)

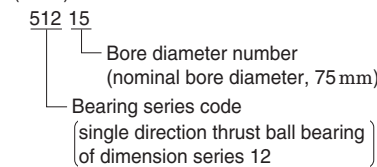

Table 6-1 Bearing series code

Bearing type	Bearing series code	Type code	Dimension series code	
			Width series ¹⁾	Diameter series
Single-row deep groove ball bearing	67	6	(1)	7
	68	6	(1)	8
	69	6	(1)	9
	160 ²⁾	6	(0)	0
	60	6	(1)	0
	62	6	(0)	2
	63	6	(0)	3
	64	6	(0)	4
Double-row deep groove ball bearing (with filling slot)	42	4	(2)	2
	43	4	(2)	3
Single-row angular contact ball bearing	79	7	(1)	9
	70	7	(1)	0
	72	7	(0)	2
	73	7	(0)	3
Double-row angular contact ball bearing (with filling slot)	32	(0)	3	2
	33	(0)	3	3
Double-row angular contact ball bearing	52	5	(3)	2
	53	5	(3)	3
Self-aligning ball bearing	12	1	(0)	2
	22	2	(2)	2
	13	1	(0)	3
	23	2	(2)	3
	112 ²⁾	1	(0) ³⁾	2
Single-row cylindrical roller bearing	113 ²⁾	1	(0) ³⁾	3
	NU 10	NU ⁴⁾	1	0
	NU 2	NU ⁴⁾	(0)	2
	NU 22	NU ⁴⁾	2	2
	NU 32	NU ⁴⁾	3	2
	NU 3	NU ⁴⁾	(0)	3
Double-row cylindrical roller bearing	NU 23	NU ⁴⁾	2	3
	NU 4	NU ⁴⁾	(0)	4
	NNU 49	NNU	4	9
	NN 30	NN	3	0
Single-row needle roller bearing	NA 48	NA	4	8
	NA 49	NA	4	9
	NA 59	NA	5	9
Double-row needle roller bearing	NA 69	NA	6	9

Bearing type	Bearing series code	Type code	Dimension series code	
			Width series	Diameter series
Tapered roller bearing	329	3	2	9
	320	3	2	0
	330	3	3	0
	331	3	3	1
	302	3	0	2
	322	3	2	2
	332	3	3	2
	303	3	0	3
	313	3	1	3
	323	3	2	3
Spherical roller bearing	239	2	3	9
	230	2	3	0
	240	2	4	0
	231	2	3	1
	241	2	4	1
	222	2	2	2
	232	2	3	2
	213 ²⁾	2	0	3
223	2	2	3	
Single direction thrust ball bearing	511	5	1	1
	512	5	1	2
	513	5	1	3
Single direction thrust ball bearing with spherical back face	514	5	1	4
	532	5	3	2
	533	5	3	3
Double direction thrust ball bearing	534	5	3	4
	522	5	2	2
Double direction thrust ball bearing with spherical back faces	523	5	2	3
	524	5	2	4
Spherical thrust roller bearing	542	5	4	2
	543	5	4	3
	544	5	4	4
Spherical thrust roller bearing	292	2	9	2
	293	2	9	3
	294	2	9	4

[Notes]

1) Width series codes in parentheses are omitted in bearing series codes.

2) These are bearing series codes customarily used.

3) Nominal outer ring width series (inner rings only are wide).

4) Besides NU type, NJ, NUP, N, NF, and NH are provided.

Table 6-2 Bearing number configuration

Order of arrangement	Basic number			Supplementary			code						
	Bearing series code	Bore diameter No.	Contact angle code	Internal design code, cage guide code	Shield/seal code	Ring shape code, lubrication hole/groove code	Material code, special treatment code	Matched pair or stack code	Internal clearance code, preload code	Spacer code	Cage material/ shape code	Tolerance code	Grease code

(Codes and descriptions)

Bearing series code

- 68 Deep groove ball bearing
- 69
- 60
- ...

(For standard bearing code, refer to Table 6-1)

Bore diameter No.

- /0.6 0.6 mm (Bore diameter)
- 1 1
- /1.5 1.5
- ...
- 9 9
- 00 10
- 01 12
- 02 15
- 03 17

- 04 20
 - /22 22
 - 05 25
 - ...
 - 96 480
- Bore diameters (mm) of bearing in the bore diameter range 04 to 96 can be obtained by multiplying their bore diameter number by five.

Contact angle code

- A (omitted) 30°
 - AC 25°
 - B 40°
 - C 15°
 - CA 20°
 - E 35°
 - B (omitted) Less than 17°
 - C 20°
 - D 28° 30'
 - DJ 28° 48' 39"
- Angular contact ball bearing
- Tapered roller bearing

Internal design code

- R High load capacity (Deep groove ball bearing, cylindrical roller bearing, tapered roller bearing)

- G Equal stand-out is provided on both sides of the ring of angular contact ball bearing (In general, C2 clearance is used)
- GST Angular contact ball bearing described above with standard internal clearance provided
- J Tapered roller bearing, whose outer ring width, contact angle and outer ring small inside diameter conform to ISO standards
- R With convex asymmetric rollers and machined cage
- RZ With convex symmetric rollers and pressed cage
- RHA With convex symmetric rollers and one-piece machined cage
- Spherical roller bearings
- V Full complement type ball or roller bearing (with no cage)

Shield/seal code

- | | | |
|----------|------------|------------------------------|
| one side | both sides | |
| Z | ZZ | Fixed shield |
| ZX | ZZX | Removable shield |
| ZU | 2ZU | Non-contact seal |
| RU | 2RU | |
| RS | 2RS | Contact seal |
| RK | 2RK | |
| U | UU | |
| RD | 2RD | Extremely light contact seal |

Ring shape code, lubrication hole/groove code

- K Inner ring tapered bore provided (1 : 12)
- K30 Inner ring tapered bore provided (1 : 30)
- N Snap ring groove on outer ring outside surface provided
- NR Snap ring groove and locating snap ring on outer ring outside surface provided

(Codes and descriptions)

- NY Creep prevention synthetic resin ring on outer ring outside surface provided
- SG Spiral groove on inner ring bore surface provided
- W Lubrication hole and lubrication groove on cylindrical roller bearing outer ring outside surface provided
- W33 Lubrication hole and lubrication groove on spherical roller bearing outer ring outside surface provided

Material code, special treatment code

- Code not given High carbon chrome bearing steel
- E Case carburizing steel
- F Case carburizing steel
- H Case carburizing steel
- Y Case carburizing steel
- ST Stainless steel
- SH Special heat treatment
- S0 Up to 150 °C (Dimension stabilizing treatment)
- S1 Up to 200 °C
- S2 Up to 250 °C

Matched pair or stack code, cage guide code

- DB Back-to-back arrangement (Angular contact ball bearing)
- DF Face-to-face arrangement
- DT Tandem arrangement
- PA With outer ring guide cage (Ball bearing)
- Q3 With roller guide cage (Roller bearing)

Internal clearance code, preload code

- C1 Smaller than C2
- C2 Smaller than standard clearance (Radial internal clearance for radial bearing)
- CN Standard clearance
- C3 Greater than standard clearance
- C4 Greater than C3
- C5 Greater than C4
- M1 to M6 (Radial internal clearance for extra-small/miniature ball bearing)
- CD2 Smaller than standard clearance (Radial internal clearance for double-row angular contact ball bearing)
- CDN Standard clearance
- CD3 Greater than standard clearance

- CM Radial internal clearance for electric bearing (Deep groove ball bearing)
- CT motor bearing (Cylindrical roller bearing)

- NA Non-interchangeable cylindrical roller bearing radial internal clearance (C1NA to C5NA)

- S Slight preload
- L Light preload (Preload for angular contact ball bearing)
- M Medium preload
- H Heavy preload

Spacer code (Spacer width (mm) is affixed to the end of each code.)

- + Inner and outer ring spacers provided (Deep groove ball bearing)
- / Inner and outer ring spacers provided (Angular contact ball bearing)
- /P Outer ring spacer provided
- /S Inner ring spacer provided
- +DP Inner and outer ring spacers provided (Cylindrical roller bearing, spherical roller bearing)
- +IDP Inner ring spacer provided
- +ODP Outer ring spacer provided

Cage material/type code

- // Steel sheet (Pressed cage)
- YS Stainless steel sheet
- FT Phenol resin
- FY High-tensile brass casting (Machined cage)
- FW High-tensile brass casting (separable type)
- MG Polyamide (Molded cage)
- FG Polyamide
- FP Carbon steel (Pin type cage)

Tolerance code (JIS)

- Omitted Class 0
- P6 Class 6
- P6X Class 6X
- P5 Class 5
- P4 Class 4
- P2 Class 2

Grease code

- A2 Alvania 2
- AC Andok C
- B5 Beacon 325
- SR Multemp SRL

7. Bearing tolerances

7-1 Tolerances and tolerance classes for bearings

Bearing tolerances and permissible values for the boundary dimensions and running accuracy of bearings are specified.

These tolerances are prescribed in JIS B 1514-1, JIS B 1514-2, and JIS B 1514-3 (roller bearings - bearing tolerances part 1: radial bearings, part 2: thrust bearings, and part 3: permissible values for chamfer dimensions). (These JIS standards are based on ISO standards.)

Bearing tolerances are standardized by classifying bearings into the following six classes (accuracy in tolerances becomes higher in the order described): 0, 6X, 6, 5, 4 and 2.

Class 0 bearings offer adequate performance for general applications; and, bearings of class 5 or higher are required for demanding applications and operating conditions including those described in Table 7-1.

These tolerances follow ISO standards, but some countries use different names for them. Tolerances for each bearing class, and organizations concerning bearings are listed in Table 7-2.

- Boundary dimension accuracy (items on shaft and housing mounting dimensions)
 - Tolerances for bore diameter, outside diameter, ring width, assembled bearing width
 - Tolerances for set bore diameter and set outside diameter of rollers
 - Tolerance limits for chamfer dimensions
 - Permissible values for width variation
 - Tolerance and permissible values for tapered bore
- Running accuracy (items on runout of rotating elements)
 - Permissible values for radial and axial runout of inner and outer rings
 - Permissible values for perpendicularity of inner ring face
 - Permissible values for perpendicularity of outer ring outside surface
 - Permissible values for thrust bearing raceway thickness

Accuracies for dimensions and running of each bearing type are listed in Tables 7-3 through 7-10; and, tolerances for tapered bore and limit values for chamfer dimensions of radial bearings are in Tables 7-11 and 7-12.

Table 7-1 High precision bearing applications

Required performance	Applications	Tolerance class
High accuracy in runout is required for rolling elements.	Acoustic / visual equipment spindles (VTR, tape recorders)	P 5, P 4
	Radar / parabola antenna slewing shafts	P 4
	Machine tool spindles	P 5, P 4, P 2, ABEC 9
	Computers, magnetic disc spindles	P 5, P 4, P 2, ABEC 9
	Aluminum foil roll necks	P 5
High speed rotation	Multi-stage mill backing bearings	P 4
	Dental spindles	P 2, ABMA 5P, ABMA 7P
	Superchargers	P 5, P 4
	Jet engine spindles and accessories	P 5, P 4
	Centrifugal separators	P 5, P 4
	LNG pumps	P 5
	Turbo molecular pump spindles and touch-down	P 5, P 4
Low friction or low friction variation is required.	Machine tool spindles	P 5, P 4, P 2, ABEC 9
	Tension reels	P 5, P 4
	Control equipment (synchronous motors, servomotors, gyro gimbals)	P 4, ABMA 7P
Low friction or low friction variation is required.	Measuring instruments	P 5
	Machine tool spindles	P 5, P 4, P 2, ABEC 9

Table 7-2 Bearing type and tolerance class

Bearing type		Applied standards	Applied tolerance class						Tolerance table	
Deep groove ball bearing		JIS B 1514-1	Class 0	–	Class 6	Class 5	Class 4	Class 2	Table 7-3	
Angular contact ball bearing			Class 0	–	Class 6	Class 5	Class 4	Class 2		
Self-aligning ball bearing			Class 0	–	–	–	–	–		
Cylindrical roller bearing			Class 0	–	Class 6	Class 5	Class 4	Class 2		
Needle roller bearing (machined ring type)		JIS B 1536-1	Class 0	–	–	–	–	–		
Tapered roller bearing	Metric series (single-row)	JIS B 1514-1	Class 0	Class 6X	(Class 6)	Class 5	Class 4	Class 2	Table 7-5	
	Metric series (double or four-row)	BAS 1002	Class 0	–	–	–	–	–	Table 7-6	
	Inch series	ANSI/ABMA	Class 4	–	Class 2	Class 3	Class 0	Class 00	Table 7-7	
	Metric series (J-series)		Class PK	–	Class PN	Class PC	Class PB	–	Table 7-8	
Spherical roller bearing		JIS B 1514-1	Class 0	–	–	–	–	–	Table 7-3	
Thrust ball bearing		JIS B 1514-2	Class 0	–	Class 6	Class 5	Class 4	–	Table 7-9	
Spherical thrust roller bearing			Class 0	–	–	–	–	–	Table 7-10	
Precision ball screw support bearing		JTEKT standards	–	–	–	Class P5Z	Class P4Z	–	–	
Double direction angular contact thrust ball bearing			–	–	–	Equivalent to class 5	Equivalent to class 4	–	–	
(Reference) Class comparison	ISO	Radial bearing	ISO 492	Normal Class	Class 6X	Class 6	Class 5	Class 4	Class 2	–
		Thrust bearing	ISO 199	Normal Class	–	Class 6	Class 5	Class 4	–	–
	DIN BS NF	Radial and thrust bearings	DIN 620 BS 6107 NF E 22-335	Normal Class	Class 6X	Class 6	Class 5	Class 4	Class 2	–
	ANSI ABMA	Radial bearing	ABMA std. 20	ABEC 1 RBEC 1	–	ABEC 3 RBEC 3	ABEC 5 RBEC 5	ABEC 7	ABEC 9	–
		Instrument ball bearing	ABMA std. 12	–	–	Class 3P	Class 5P Class 5T	Class 7P Class 7T	Class 9P	Table 7-4
		Tapered roller bearing	ABMA std. 19	Class 4 Class K	–	Class 2 Class N	Class 3 Class C	Class 0 Class B	Class 00 Class A	Table 7-7

(Reference) Standards and organizations concerned with bearings

- JIS : Japanese Industrial Standard
- BAS : The Japan Bearing Industrial Association Standard
- ISO : International Organization for Standardization
- ANSI : American National Standards Institute, Inc.
- ABMA : American Bearing Manufacturers Association
- DIN : Deutsches Institut für Normung
- BS : British Standards Institution
- NF : Association Francaise de Normalisation

Table 7-3 (2) Radial bearing tolerances (tapered roller bearings excluded)

(3) Outer ring (outside diameter)

Unit : μm

Nominal outside dia. D mm	Single plane mean outside diameter deviation Δ_{Dmp}												Single outside diameter deviation $\Delta_{Ds}^{(1)}$				Single plane outside diameter variation V_{Dsp}													Mean outside diameter variation V_{Dmp}						Nominal outside dia. D mm					
	class 0						class 6						class 5 ⁽²⁾		class 2		Diameter series 7, 8, 9				Diameter series 0, 1				Diameter series 2, 3, 4					Shielded/sealed type Diameter series		class 0 ⁽²⁾						class 6 ⁽²⁾		over	up to
	upper		lower		upper		lower		upper		lower		upper		lower		upper		lower		max.		max.		max.					max.		max.									
-	2.5	0 - 8						0 - 7						0 - 5		0 - 4		10 9 5 4				8 7 4 3				6 5 4 3 2.5					10 9		6 5 3 2 1.5						-	2.5	
2.5	6	0 - 8						0 - 7						0 - 5		0 - 4		10 9 5 4				8 7 4 3				6 5 4 3 2.5					10 9		6 5 3 2 1.5						2.5	6	
6	18	0 - 8						0 - 7						0 - 5		0 - 4		10 9 5 4				8 7 4 3				6 5 4 3 2.5					10 9		6 5 3 2 1.5						6	18	
18	30	0 - 9						0 - 8						0 - 6		0 - 5		12 10 6 5				9 8 5 4				7 6 5 4 4					12 10		7 6 3 2.5 2						18	30	
30	50	0 - 11						0 - 9						0 - 7		0 - 6		14 11 7 6				11 9 5 5				8 7 5 5 4					16 13		8 7 4 3 2						30	50	
50	80	0 - 13						0 - 11						0 - 9		0 - 7		16 14 9 7				13 11 7 5				10 8 7 5 4					20 16		10 8 5 3.5 2						50	80	
80	120	0 - 15						0 - 13						0 - 10		0 - 8		19 16 10 8				19 16 8 6				11 10 8 6 5					26 20		11 10 5 4 2.5						80	120	
120	150	0 - 18						0 - 15						0 - 11		0 - 9		23 19 11 9				23 19 8 7				14 11 8 7 5					30 25		14 11 6 5 2.5						120	150	
150	180	0 - 25						0 - 18						0 - 13		0 - 10		31 23 13 10				31 23 10 8				19 14 10 8 7					38 30		19 14 7 5 3.5						150	180	
180	250	0 - 30						0 - 20						0 - 15		0 - 11		38 25 15 11				38 25 11 8				23 15 11 8 8					-		23 15 8 6 4						180	250	
250	315	0 - 35						0 - 25						0 - 18		0 - 13		44 31 18 13				44 31 14 10				26 19 14 10 8					-		26 19 9 7 4						250	315	
315	400	0 - 40						0 - 28						0 - 20		0 - 15		50 35 20 15				50 35 15 11				30 21 15 11 10					-		30 21 10 8 5						315	400	
400	500	0 - 45						0 - 33						0 - 23		0 - 17		56 41 23 17				56 41 17 13				34 25 17 13					-		34 25 12 9 -						400	500	
500	630	0 - 50						0 - 38						0 - 28		0 - 20		63 48 28 20				63 48 21 15				38 29 21 15					-		38 29 14 10 -						500	630	
630	800	0 - 75						0 - 45						0 - 35		-		94 56 35 -				94 56 26 -				55 34 26 -					-		55 34 18 -						630	800	
800	1000	0 - 100						0 - 60						0 - 50		-		125 75 50 -				125 75 38 -				75 45 38 -					-		75 45 25 -						800	1000	
1000	1250	0 - 125						0 - 75						0 - 63		-		156 94 63 -				156 94 47 -				94 56 47 -					-		94 56 31 -						1000	1250	
1250	1600	0 - 160						0 - 90						0 - 80		-		200 113 80 -				200 113 60 -				120 68 60 -					-		120 68 40 -						1250	1600	
1600	2000	0 - 200						0 - 120						-		-		250 150 -				250 150 -				150 90 -					-		150 90 -						1600	2000	
2000	2500	0 - 250						-						-		-		313 -				313 -				188 -					-		188 -						2000	2500	

(4) Outer ring (running accuracy and width)

Unit : μm

Nominal outside dia. D mm	Radial runout of assembled bearing outer ring K_{ea}												Ring width variation $V_{Cs}^{(3)}$										
	class 0				class 6				class 5				class 2				class 5		class 4		class 2		classes 0, 6, 5, 4, 2
over	up to	max.												upper		lower							
-	2.5	15	8	5	3	1.5	8	4	1.5	8	5	1.5				5	2.5	1.5					
2.5	6	15	8	5	3	1.5	8	4	1.5	8	5	1.5				5	2.5	1.5					
6	18	15	8	5	3	1.5	8	4	1.5	8	5	1.5				5	2.5	1.5					
18	30	15	9	6	4	2.5	8	4	1.5	8	5	2.5				5	2.5	1.5					
30	50	20	10	7	5	2.5	8	4	1.5	8	5	2.5				5	2.5	1.5					
50	80	25	13	8	5	4	8	4	1.5	10	5	4				6	3	1.5					
80	120	35	18	10	6	5	9	5	2.5	11	6	5				8	4	2.5					
120	150	40	20	11	7	5	10	5	2.5	13	7	5				8	5	2.5					
150	180	45	23	13	8	5	10	5	2.5	14	8	5				8	5	2.5					
180	250	50	25	15	10	7	11	7	4	15	10	7				10	7	4					
250	315	60	30	18	11	7	13	8	5	18	10	7				11	7	5					
315	400	70	35	20	13	8	13	10	7	20	13	8				13	8	7					
400	500	80	40	23	15	-	15	12	-	23	15	-				15	9	-					
500	630	100	50	25	18	-	18	13	-	25	18	-				18	11	-					
630	800	120	60	30	-	-	20	-	-	30	-	-				20	-	-					
800	1000	140	75	40	-	-	23	-	-	40	-	-				23	-	-					
1000	1250	160	85	45	-	-	30	-	-	45	-	-				30	-	-					
1250	1600	190	95	60	-	-	45	-	-	60	-	-				45	-	-					
1600	2000	220	-	-	-	-	-	-	-	-	-	-				-	-	-					
2000	2500	250	-	-	-	-	-	-	-	-	-	-				-	-	-					

S_D : perpendicularity of outer ring outside surface with respect to the face
 S_{ea} : axial runout of assembled bearing outer ring
 Δ_{Cs} : deviation of a single outer ring width

[Notes]

- 1) These shall be applied to bearings of diameter series 0, 1, 2, 3 and 4.
- 2) Shall be applied when locating snap ring is not fitted.
- 3) These shall be applied to deep groove ball bearings and angular contact ball bearings.
- 4) These shall not be applied to flanged bearings.
- 5) These shall not be applied to shielded bearings and sealed bearings.

[Remark]

Values in Italics are prescribed in JTEKT standards.

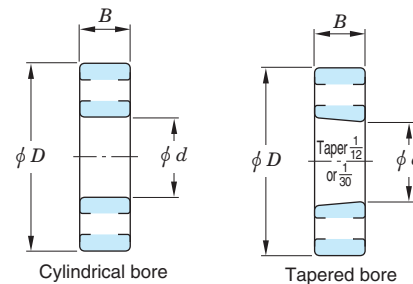

d : nominal bore diameter
 D : nominal outside diameter
 B : nominal assembled bearing width

7. Bearing tolerances

(Refer.) Table 7-4 Tolerances for measuring instrument ball bearings (inch series)

= ANSI/ABMA standards = (reference)

(1) Inner ring and outer ring width

Unit : μm

Nominal bore dia. d mm	Single plane mean bore diameter deviation Δd_{mp}		Single bore diameter deviation Δd_s		Single plane bore diameter variation V_{dsp}		Mean bore diameter variation V_{dmp}		Radial runout of assembled bearing inner ring K_{ia}			Axial runout of assembled bearing inner ring S_{ia}			Perpendicularity of inner ring face with respect to the bore S_d			Single inner or outer ring width deviation $\Delta B_s, \Delta C_s$		Inner or outer ring width variation V_{Bs}, V_{Cs}						
	classes 5P, 7P		class 9P		classes 5P, 7P		class 9P		classes 5P, 7P, 9P			class 5P, 7P, 9P			class 5P, 7P, 9P			classes 5P, 7P, 9P		class 5P, 7P, 9P						
	upper	lower	upper	lower	upper	lower	upper	lower	max.			max.			max.			upper	lower	max.						
- 18	0	-5.1	0	-2.5	0	-5.1	0	-2.5	2.5	1.3	2.5	1.3	3.8	2.5	1.3	7.6	2.5	1.3	7.6	2.5	1.3	0	-25.4	5.1	2.5	1.3
10 18	0	-5.1	0	-2.5	0	-5.1	0	-2.5	2.5	1.3	2.5	1.3	3.8	2.5	1.3	7.6	2.5	1.3	7.6	2.5	1.3	0	-25.4	5.1	2.5	1.3
18 30	0	-5.1	0	-2.5	0	-5.1	0	-2.5	2.5	1.3	2.5	1.3	3.8	3.8	2.5	7.6	3.8	1.3	7.6	3.8	1.3	0	-25.4	5.1	2.5	1.3

(2) Outer ring

Unit : μm

Nominal outside dia. D mm	Single plane mean outside diameter deviation ΔD_{mp}		Single outside diameter deviation ΔD_s		Single plane outside diameter variation V_{Dsp}			Mean outside diameter variation V_{Dmp}			Radial runout of assembled bearing outer ring K_{ea}			Axial runout of assembled bearing outer ring S_{ea}			Perpendicularity of outer ring outside surface with respect to the face S_D			Single outer ring flange outside diameter deviation ΔD_{1s}		Single outer ring flange width deviation ΔC_{1s}				
	classes 5P, 7P		class 9P		classes 5P, 7P		class 9P		classes 5P, 7P, 9P			class 5P, 7P, 9P			class 5P, 7P, 9P			class 5P, 7P, 9P			classes 5P, 7P		classes 5P, 7P			
	upper	lower	upper	lower	upper	lower	upper	lower	upper	lower	upper	lower	upper	lower	upper	lower	upper	lower	upper	lower	upper	lower	upper	lower		
- 18	0	-5.1	0	-2.5	0	-5.1	+1	-6.1	0	-2.5	2.5	5.1	1.3	2.5	5.1	1.3	7.6	3.8	1.3	7.6	3.8	1.3	0	-25.4	0	-50.8
18 30	0	-5.1	0	-3.8	0	-5.1	+1	-6.1	0	-3.8	2.5	5.1	2	2.5	5.1	2	7.6	5.1	2.5	7.6	3.8	1.3	0	-25.4	0	-50.8
30 50	0	-5.1	0	-3.8	0	-5.1	+1	-6.1	0	-3.8	2.5	5.1	2	2.5	5.1	2	7.6	5.1	2.5	7.6	3.8	1.3	0	-25.4	0	-50.8

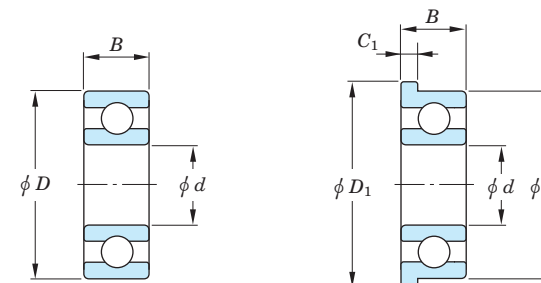

d : nominal bore diameter
 D : nominal outside diameter
 B : nominal assembled bearing width
 D_1 : nominal outer ring flange outside diameter
 C_1 : nominal outer ring flange width

7. Bearing tolerances

Table 7-5 (1) Tolerances for metric series tapered roller bearings = JIS B 1514-1 =

(1) Inner ring

Unit : μ m

Nominal bore diameter d mm	Single plane mean bore diameter deviation Δ_{dmp}								Single bore diameter deviation Δ_{ds}				Single plane bore diameter variation V_{dsp}				Mean bore diameter variation V_{dmp}				Radial runout of assembled bearing inner ring K_{ia}								Single inner ring width deviation Δ_{Bs}								Nominal bore diameter d mm								
	classes 0, 6X		classes 6, 5		class 4		class 2		class 4		class 2		classes 0, 6X		class 6		class 5		class 4		class 2		classes 0, 6X		class 6		class 5		class 4		class 2		class 0		class 6X		class 6		classes 5, 4		class 2		over	up to	
	upper	lower	upper	lower	upper	lower	upper	lower	upper	lower	upper	lower	upper	lower	upper	lower	upper	lower	upper	lower	upper	lower	upper	lower	upper	lower	upper	lower	upper	lower	upper	lower	upper	lower	upper	lower	upper	lower							
over	up to	upper	lower	upper	lower	upper	lower	upper	lower	upper	lower	upper	lower	upper	lower	upper	lower	upper	lower	upper	lower	upper	lower	upper	lower	upper	lower	upper	lower	upper	lower	upper	lower	upper	lower	upper	lower	over	up to						
10	18	0	-12	0	-7 ¹⁾	0	-5	0	-4	0	-5	0	-4	12	-	5	4	2.5	9	-	5	4	1.5	15	-	5	3	2	7	3	1.5	3	2	0	-120	0	-50	-	-	0	-200	0	-200	10	18
18	30	0	-12	0	-8	0	-6	0	-4	0	-6	0	-4	12	8	6	5	2.5	9	6	5	4	1.5	18	8	5	3	2.5	8	4	1.5	4	2.5	0	-120	0	-50	0	-120	0	-200	0	-200	18	30
30	50	0	-12	0	-10	0	-8	0	-5	0	-8	0	-5	12	10	8	6	3	9	8	5	5	2	20	10	6	4	2.5	8	4	2	4	2.5	0	-120	0	-50	0	-120	0	-240	0	-240	30	50
50	80	0	-15	0	-12	0	-9	0	-5	0	-9	0	-5	15	12	9	7	4	11	9	6	5	2	25	10	7	4	3	8	5	2	4	3	0	-150	0	-50	0	-150	0	-300	0	-300	50	80
80	120	0	-20	0	-15	0	-10	0	-6	0	-10	0	-6	20	15	11	8	5	15	11	8	5	2.5	30	13	8	5	3	9	5	2.5	5	3	0	-200	0	-50	0	-200	0	-400	0	-400	80	120
120	180	0	-25	0	-18	0	-13	0	-7	0	-13	0	-7	25	18	14	10	7	19	14	9	7	3.5	35	18	11	6	4	10	6	3.5	7	4	0	-250	0	-50	0	-250	0	-500	0	-500	120	180
180	250	0	-30	0	-22	0	-15	0	-8	0	-15	0	-8	30	22	17	11	7	23	16	11	8	4	50	20	13	8	5	11	7	5	8	5	0	-300	0	-50	0	-300	0	-600	0	-600	180	250
250	315	0	-35	0	-25 ¹⁾	0	-18	0	-8	0	-18	0	-8	35	25	19	12	8	26	19	13	9	5	60	30	13	9	6	13	8	5.5	9	6	0	-350	0	-50	0	-350	0	-700	0	-700	250	315
315	400	0	-40	0	-30 ¹⁾	-	-	-	-	-	-	-	-	40	30	23	-	-	30	23	15	-	-	70	35	15	-	-	15	-	-	-	-	0	-400	0	-50	0	-400	0	-800 ²⁾	-	-	315	400
400	500	0	-45	0	-35 ¹⁾	-	-	-	-	-	-	-	-	45	35	28	-	-	34	26	17	-	-	80	40	20	-	-	17	-	-	-	-	0	-450	0	-50	0	-450	0	-900 ²⁾	-	-	400	500
500	630	0	-60	0	-40 ¹⁾	-	-	-	-	-	-	-	-	60	40	35	-	-	40	30	20	-	-	90	50	25	-	-	20	-	-	-	-	0	-500	-	-	0	-500	0	-1 100 ²⁾	-	-	500	630
630	800	0	-75	0	-50 ¹⁾	-	-	-	-	-	-	-	-	75	50	45	-	-	45	38	25	-	-	100	60	30	-	-	25	-	-	-	-	0	-750	-	-	0	-750	0	-1 600 ²⁾	-	-	630	800
800	1 000	0	-100	0	-60 ¹⁾	-	-	-	-	-	-	-	-	100	60	60	-	-	55	45	30	-	-	115	75	37	-	-	30	-	-	-	-	0	-1 000	-	-	0	-1 000	0	-2 000 ²⁾	-	-	800	1 000

S_d : perpendicularity of inner ring face with respect to the bore
 S_{ia} : axial runout of assembled bearing inner ring

(2-1) Outer ring

Unit : μ m

Nominal outside diameter D mm	Single plane mean outside diameter deviation Δ_{Dmp}								Single outside diameter deviation Δ_{Ds}				Single plane outside diameter variation V_{Dsp}				Mean outside diameter variation V_{Dmp}				Radial runout of assembled bearing outer ring K_{ea}								Perpendicularity of outer ring outside surface with respect to the face $S_{D^3)}$								Axial runout of assembled bearing outer ring $S_{ea^3)}$								Nominal outside diameter D mm	
	classes 0, 6X		classes 6, 5		class 4		class 2		class 4		class 2		classes 0, 6X		class 6		class 5		class 4		class 2		classes 0, 6X		class 6		class 5		class 4		class 2		class 0		class 6X		class 6		classes 5, 4, 2		over	up to				
	upper	lower	upper	lower	upper	lower	upper	lower	upper	lower	upper	lower	upper	lower	upper	lower	upper	lower	upper	lower	upper	lower	upper	lower	upper	lower	upper	lower	upper	lower	upper	lower	upper	lower	upper	lower	upper	lower								
over	up to	upper	lower	upper	lower	upper	lower	upper	lower	upper	lower	upper	lower	upper	lower	upper	lower	upper	lower	upper	lower	upper	lower	upper	lower	upper	lower	upper	lower	upper	lower	upper	lower	upper	lower	upper	lower	over	up to							
18	30	0	-12	0	-8 ¹⁾	0	-6	0	-5	0	-6	0	-5	12	-	6	5	4	9	-	5	4	2.5	18	-	6	4	2.5	8	4	1.5	5	2.5	-	-	-	-	18	30							
30	50	0	-14	0	-9	0	-7	0	-5	0	-7	0	-5	14	9	7	5	4	11	7	5	5	2.5	20	10	7	5	2.5	8	4	2	5	2.5	-	-	-	-	30	50							
50	80	0	-16	0	-11	0	-9	0	-6	0	-9	0	-6	16	11	8	7	4	12	8	6	5	2.5	25	13	8	5	4	8	4	2.5	5	4	-	-	-	-	50	80							
80	120	0	-18	0	-13	0	-10	0	-6	0	-10	0	-6	18	13	10	8	5	14	10	7	5	3	35	18	10	6	5	9	5	3	6	5	-	-	-	-	80	120							
120	150	0	-20	0	-15	0	-11	0	-7	0	-11	0	-7	20	15	11	8	5	15	11	8	6	3.5	40	20	11	7	5	10	5	3.5	7	5	-	-	-	-	120	150							
150	180	0	-25	0	-18	0	-13	0	-7	0	-13	0	-7	25	18	14	10	7	19	14	9	7	4	45	23	13	8	5	10	5	4	8	5	-	-	-	-	150	180							
180	250	0	-30	0	-20	0	-15	0	-8	0	-15	0	-8	30	20	15	11	8	23	15	10	8	5	50	25	15	10	7	11	7	5	10	7	-	-	-	-	180	250							
250	315	0	-35	0	-25	0	-18	0	-9	0	-18	0	-9	35	25	19	14	8	26	19	13	9	5	60	30	18	11	7	13	8	6	10	7	-	-	-	-	250	315							
315	400	0	-40	0	-28	0	-20	0	-10	0	-20	0	-10	40	28	22	15	10	30	21	14	10	6	70	35	20	13	8	13	10	7	13	8	-	-	-	-	315	400							
400	500	0	-45	0	-33 ¹⁾	-	-	-	-	-	-	-	-	45	33	26	-	-	34	25	17	-	-	80	40	24	-	-	17	-	-	-	-	-	-	-	400	500								
500	630	0	-50	0	-38 ¹⁾	-	-	-	-	-	-	-	-	60	38	30	-	-	38	29	20	-	-	100	50	30	-	-	20	-	-	-	-	-	-	-	500	630								
630	800	0	-75	0	-45 ¹⁾	-	-	-	-	-	-	-	-	80	45	38	-	-	55	34	25	-	-	120	60	36	-	-	25	-	-	-	-	-	-	-	630	800								
800	1 000	0	-100	0	-60 ¹⁾	-	-	-	-	-	-	-	-	100	60	50	-	-	75	45	30	-	-	140	75	43	-	-	30	-	-	-	-	-	-	-	800	1 000								
1 000	1 250	0	-125	0	-80 ¹⁾	-	-	-	-	-	-	-	-	130	75	65	-	-	90	56	38	-	-	160	85	52	-	-	38	-	-	-	-	-	-	-	1 000	1 250								
1 250	1 600	0	-160	0	-100 ¹⁾	-	-	-	-	-	-	-	-	170	90	90	-	-	100	68	50	-	-	180	95	62	-	-	50	-	-	-	-	-	-	-	1 250	1 600								

$S_{D^3)}$: perpendicularity of outer ring outside surface with respect to the face
 $S_{ea^3)}$: axial runout of assembled bearing outer ring

(2-2) Outer ring

Unit : μ m

Nominal bore diameter d mm	Single outer ring width deviation Δ_{Cs}				Nominal bore diameter d mm
	class 6X		classes 0, 6, 5, 4, 2		
	upper	lower	upper	lower	
over	up to	upper	lower	upper	lower
10	18	0	-100	10	18
18	30	0	-100	18	30
30	50	0	-100	30	50
50	80	0	-100	50	80
80	120	0	-100	80	120
120	180	0	-100	120	180
180	250	0	-100	180	250
250	315	0	-100	250	315
315	400	0	-100	315	400
400	500	0	-100	400	500
500	630	-	-	500	630
630	800	-	-	630	800
800	1 000	-	-	800	1 000
1 000	1 250	-	-	1 000	1 250
1 250	1 600	-	-	1 250	1 600

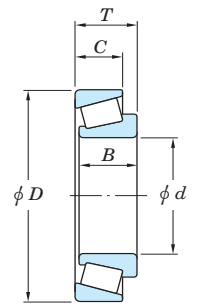

d : nominal bore diameter
 D : nominal outside diameter
 B : nominal inner ring width
 C : nominal outer ring width
 T : nominal assembled bearing width

[Notes] 1) Class 6 values are prescribed in JTEKT standards.
 2) These shall be applied to bearings of tolerance class 5.
 3) These shall not be applied to flanged bearings.
 [Remark] Values in Italics are prescribed in JTEKT standards.

Table 7-5 (2) Tolerances for metric series tapered roller bearings

(3) Assembled bearing width and effective width

Unit : μm

Nominal bore diameter d mm		Actual bearing width deviation ΔT_s								Actual effective inner sub-unit width deviation ΔT_{1s}									
		class 0		class 6X		class 6		classes 5, 4		class 2		class 0		class 6X		classes 5, 4		class 2	
		upper	lower	upper	lower	upper	lower	upper	lower	upper	lower	upper	lower	upper	lower	upper	lower	upper	lower
over	up to																		
-	10	+200	0	+100	0	-	-	+200	-200	+200	-200	+100	0	+50	0	+100	-100	+100	-100
10	18	+200	0	+100	0	+200	0	+200	-200	+200	-200	+100	0	+50	0	+100	-100	+100	-100
18	30	+200	0	+100	0	+200	0	+200	-200	+200	-200	+100	0	+50	0	+100	-100	+100	-100
30	50	+200	0	+100	0	+200	0	+200	-200	+200	-200	+100	0	+50	0	+100	-100	+100	-100
50	80	+200	0	+100	0	+200	0	+200	-200	+200	-200	+100	0	+50	0	+100	-100	+100	-100
80	120	+200	-200	+100	0	+200	-200	+200	-200	+200	-200	+100	-100	+50	0	+100	-100	+100	-100
120	180	+350	-250	+150	0	+350	-250	+350	-250	+200	-250	+150	-150	+50	0	+150	-150	+100	-100
180	250	+350	-250	+150	0	+350	-250	+350	-250	+200	-300	+150	-150	+50	0	+150	-150	+100	-150
250	315	+350	-250	+200	0	+350	-250	+350	-250	+200	-300	+150	-150	+100	0	+150	-150	+100	-150
315	400	+400	-400	+200	0	+400	-400	+400	-400 ¹⁾	-	-	+200	-200	+100	0	+200	-200 ¹⁾	-	-
400	500	+450	-450	+200	0	+400	-400	+450	-450 ¹⁾	-	-	+225	-225	+100	0	+225	-225 ¹⁾	-	-
500	630	+500	-500	-	-	+500	-500	+500	-500 ¹⁾	-	-	-	-	-	-	-	-	-	-
630	800	+600	-600	-	-	+600	-600	+600	-600 ¹⁾	-	-	-	-	-	-	-	-	-	-
800	1 000	+750	-750	-	-	+750	-750	+750	-750 ¹⁾	-	-	-	-	-	-	-	-	-	-

Nominal bore diameter d mm		Actual effective outer ring width deviation ΔT_{2s}							
		class 0		class 6X		classes 5, 4		class 2	
		upper	lower	upper	lower	upper	lower	upper	lower
over	up to								
-	10	+100	0	+50	0	+100	-100	+100	-100
10	18	+100	0	+50	0	+100	-100	+100	-100
18	30	+100	0	+50	0	+100	-100	+100	-100
30	50	+100	0	+50	0	+100	-100	+100	-100
50	80	+100	0	+50	0	+100	-100	+100	-100
80	120	+100	-100	+50	0	+100	-100	+100	-100
120	180	+200	-100	+100	0	+200	-100	+100	-150
180	250	+200	-100	+100	0	+200	-100	+100	-150
250	315	+200	-100	+100	0	+200	-100	+100	-150
315	400	+200	-200	+100	0	+200	-200 ¹⁾	-	-
400	500	+225	-225	+100	0	+225	-225 ¹⁾	-	-
500	630	-	-	-	-	-	-	-	-
630	800	-	-	-	-	-	-	-	-
800	1 000	-	-	-	-	-	-	-	-

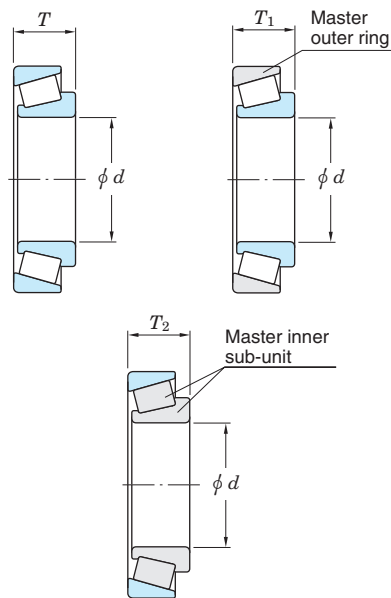

d : nominal bore diameter
 T : nominal assembled bearing width
 T_1 : nominal effective width of inner sub-unit
 T_2 : nominal effective width of outer ring

Table 7-6 Tolerances for metric series double-row and four-row tapered roller bearings (class 0) = BAS 1002 =

(1) Inner ring, outer ring width and overall width

Unit : μm

Nominal bore diameter d mm		Single plane mean bore diameter deviation Δd_{mp}		Single plane bore diameter variation V_{dsp}	Mean bore diameter variation V_{dmp}	K_{ia}	Single outer ring or inner ring width deviation $\Delta B_s, \Delta C_s$		Actual overall inner rings/outer rings width deviation			
									Double-row ΔT_s		Four-row $\Delta T_s, \Delta W_s$	
									upper	lower	upper	lower
over	up to			max.	max.	max.	upper	lower	upper	lower	upper	lower
30	50	0	-12	12	9	20	0	-120	+240	-240	-	-
50	80	0	-15	15	11	25	0	-150	+300	-300	-	-
80	120	0	-20	20	15	30	0	-200	+400	-400	+500	-500
120	180	0	-25	25	19	35	0	-250	+500	-500	+600	-600
180	250	0	-30	30	23	50	0	-300	+600	-600	+750	-750
250	315	0	-35	35	26	60	0	-350	+700	-700	+900	-900
315	400	0	-40	40	30	70	0	-400	+800	-800	+1 000	-1 000
400	500	0	-45	45	34	80	0	-450	+900	-900	+1 200	-1 200
500	630	0	-60	60	40	90	0	-500	+1 000	-1 000	+1 200	-1 200
630	800	0	-75	75	45	100	0	-750	+1 500	-1 500	-	-
800	1 000	0	-100	100	55	115	0	-1 000	+1 500	-1 500	-	-

K_{ia} : radial runout of assembled bearing inner ring

(2) Outer ring

Unit : μm

Nominal outside diameter D mm		Single plane mean outside diameter deviation ΔD_{mp}		Single plane outside diameter variation V_{Dsp}	Mean outside diameter variation V_{Dmp}	K_{ea}					
							upper	lower	max.	max.	max.
							over	up to			
50	80	0	-16	16	12	25					
80	120	0	-18	18	14	35					
120	150	0	-20	20	15	40					
150	180	0	-25	25	19	45					
180	250	0	-30	30	23	50					
250	315	0	-35	35	26	60					
315	400	0	-40	40	30	70					
400	500	0	-45	45	34	80					
500	630	0	-50	60	38	100					
630	800	0	-75	80	55	120					
800	1 000	0	-100	100	75	140					
1 000	1 250	0	-125	130	90	160					
1 250	1 600	0	-160	170	100	180					

K_{ea} : radial runout of assembled bearing outer ring

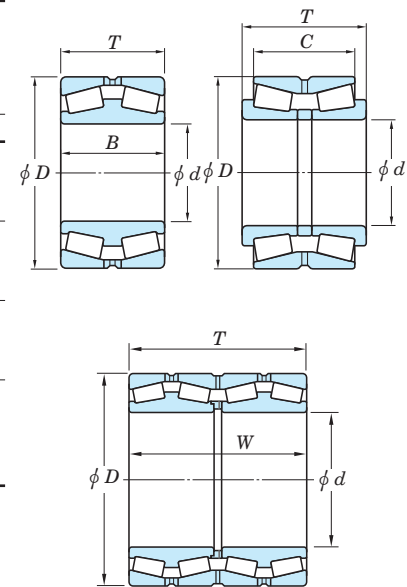

d : nominal bore diameter
 D : nominal outside diameter
 B : nominal double inner ring width
 C : nominal double outer ring width
 T, W : nominal overall width of outer rings (inner rings)

Table 7-7 Tolerances and permissible values for inch series tapered roller bearings = ANSI/ABMA 19 =

(1) Inner ring Unit : μm

Applied bearing type	Nominal bore diameter d , mm (1/25.4)		Deviation of a single bore diameter Δ_{ds}									
			class 4		class 2		class 3		class 0		class 00	
	over	up to	upper	lower	upper	lower	upper	lower	upper	lower	upper	lower
All types	-	76.2 (3.0)	+ 13	0	+13	0	+13	0	+13	0	+8	0
	76.2 (3.0)	266.7 (10.5)	+ 25	0	+25	0	+13	0	+13	0	+8	0
	266.7 (10.5)	304.8 (12.0)	+ 25	0	+25	0	+13	0	+13	0	+8	0
	304.8 (12.0)	609.6 (24.0)	+ 51	0	+51	0	+25	0	-	-	-	-
	609.6 (24.0)	914.4 (36.0)	+ 76	0	-	-	+38	0	-	-	-	-
	914.4 (36.0)	1 219.2 (48.0)	+102	0	-	-	+51	0	-	-	-	-
	1 219.2 (48.0)	-	+127	0	-	-	+76	0	-	-	-	-

(2) Outer ring Unit : μm

Applied bearing type	Nominal outside diameter D , mm (1/25.4)		Deviation of a single outside diameter Δ_{Ds}									
			class 4		class 2		class 3		class 0		class 00	
	over	up to	upper	lower	upper	lower	upper	lower	upper	lower	upper	lower
All types	-	266.7 (10.5)	+ 25	0	+25	0	+13	0	+13	0	+8	0
	266.7 (10.5)	304.8 (12.0)	+ 25	0	+25	0	+13	0	+13	0	+8	0
	304.8 (12.0)	609.6 (24.0)	+ 51	0	+51	0	+25	0	-	-	-	-
	609.6 (24.0)	914.4 (36.0)	+ 76	0	+76	0	+38	0	-	-	-	-
	914.4 (36.0)	1 219.2 (48.0)	+102	0	-	-	+51	0	-	-	-	-
	1 219.2 (48.0)	-	+127	0	-	-	+76	0	-	-	-	-

(3) Radial runout of assembled bearing inner ring/outer ring Unit : μm

Applied bearing type	Nominal outside diameter D , mm (1/25.4)		Radial runout of inner ring/outer ring K_{ia}, K_{ea}				
			class 4	class 2	class 3	class 0	class 00
	over	up to	max.	max.	max.	max.	max.
All types	-	266.7 (10.5)	51	38	8	4	2
	266.7 (10.5)	304.8 (12.0)	51	38	8	4	2
	304.8 (12.0)	609.6 (24.0)	51	38	18	-	-
	609.6 (24.0)	914.4 (36.0)	76	51	51	-	-
	914.4 (36.0)	1 219.2 (48.0)	76	-	76	-	-
	1 219.2 (48.0)	-	76	-	76	-	-

(4) Assembled bearing width and overall width Unit : μm

Applied bearing type	Nominal bore diameter d , mm (1/25.4)		Nominal outside diameter D , mm (1/25.4)		Deviation of the actual bearing width and overall width of inner rings/outer rings Δ_{Ts}, Δ_{Ws}							
					class 4		class 2		class 3		classes 0,00	
	over	up to	over	up to	upper	lower	upper	lower	upper	lower	upper	lower
Single-row	-	101.6 (4.0)	-	-	+ 203	0	+ 203	0	+ 203	- 203	+ 203	- 203
	101.6 (4.0)	266.7 (10.5)	-	-	+ 356	- 254	+ 203	0	+ 203	- 203	+ 203	- 203
	266.7 (10.5)	304.8 (12.0)	-	-	+ 356	- 254	+ 203	0	+ 203	- 203	+ 203	- 203 ¹⁾
	304.8 (12.0)	609.6 (24.0)	-	508.0 (20.0)	-	-	+ 381	- 381	+ 203	- 203	-	-
	609.6 (24.0)	914.4 (36.0)	508.0 (20.0)	-	-	-	+ 381	- 381	+ 381	- 381	-	-
	914.4 (36.0)	1 219.2 (48.0)	-	-	+ 381	- 381	-	-	+ 381	- 381	-	-
Double-row	-	101.6 (4.0)	-	-	+ 406	0	+ 406	0	+ 406	- 406	+ 406	- 406
	101.6 (4.0)	266.7 (10.5)	-	-	+ 711	- 508	+ 406	- 203	+ 406	- 406	+ 406	- 406
	266.7 (10.5)	304.8 (12.0)	-	-	+ 711	- 508	+ 406	- 203	+ 406	- 406	+ 406	- 406 ¹⁾
	304.8 (12.0)	609.6 (24.0)	-	508.0 (20.0)	-	-	+ 762	- 762	+ 406	- 406	-	-
	609.6 (24.0)	914.4 (36.0)	508.0 (20.0)	-	-	-	+ 762	- 762	+ 762	- 762	-	-
Double-row (TNA type)	-	127.0 (5.0)	-	-	-	-	+ 254	0	+ 254	0	-	-
	127.0 (5.0)	-	-	-	-	-	+ 762	0	+ 762	0	-	-
Four-row	Total dimensional range		-	-	+1 524	-1 524	+1 524	-1 524	+1 524	-1 524	+1 524	-1 524

[Note] 1) These shall be applied to bearings of class 0.

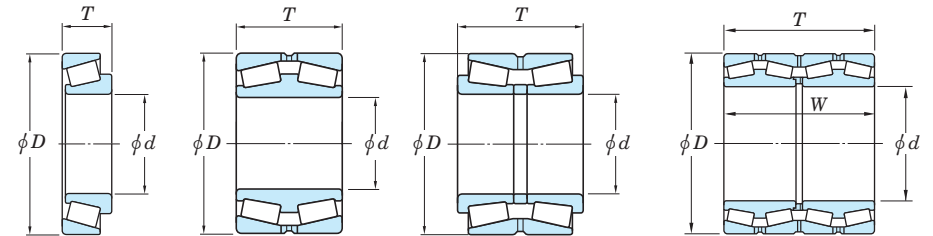

d : nominal bore diameter
 D : nominal outside diameter
 T, W : nominal assembled bearing width and nominal overall width of outer rings (inner rings)

7. Bearing tolerances

Table 7-8 Tolerances for metric J series tapered roller bearings ¹⁾

(1) Bore diameter and width of inner ring and assembled bearing width

Unit : μm

Nominal bore diameter d mm		Deviation of a single bore diameter Δ_{ds}								Deviation of a single inner ring width Δ_{Bs}								Deviation of the actual bearing width Δ_{Ts}								Nominal bore diameter d mm	
		class PK		class PN		class PC		class PB		class PK		class PN		class PC		class PB		class PK		class PN		class PC		class PB			
over	up to	upper	lower	upper	lower	upper	lower	upper	lower	upper	lower	upper	lower	upper	lower	upper	lower	upper	lower	upper	lower	upper	lower	upper	lower	over	up to
10	18	0	-12	0	-12	0	-7	0	-5	0	-100	0	-50	0	-200	0	-200	+200	0	+100	0	+200	-200	+200	-200	10	18
18	30	0	-12	0	-12	0	-8	0	-6	0	-100	0	-50	0	-200	0	-200	+200	0	+100	0	+200	-200	+200	-200	18	30
30	50	0	-12	0	-12	0	-10	0	-8	0	-100	0	-50	0	-200	0	-200	+200	0	+100	0	+200	-200	+200	-200	30	50
50	80	0	-15	0	-15	0	-12	0	-9	0	-150	0	-50	0	-300	0	-300	+200	0	+100	0	+200	-200	+200	-200	50	80
80	120	0	-20	0	-20	0	-15	0	-10	0	-150	0	-50	0	-300	0	-300	+200	-200	+100	0	+200	-200	+200	-200	80	120
120	180	0	-25	0	-25	0	-18	0	-13	0	-200	0	-50	0	-300	0	-300	+350	-250	+150	0	+350	-250	+200	-250	120	180
180	250	0	-30	0	-30	0	-22	0	-15	0	-200	0	-50	0	-350	0	-350	+350	-250	+150	0	+350	-250	+200	-300	180	250
250	315	0	-35	0	-35	0	-22	0	-15	0	-200	0	-50	0	-350	0	-350	+350	-250	+200	0	+350	-300	+200	-300	250	315

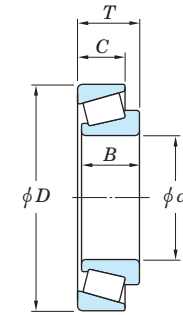

d : nominal bore diameter
 D : nominal outside diameter
 B : nominal inner ring width
 C : nominal outer ring width
 T : nominal assembled bearing width

(2) Outside diameter and width of outer ring and radial runout of assembled bearing inner ring/ outer ring

Unit : μm

Nominal outside diameter D mm		Deviation of a single outside diameter Δ_{Ds}								Deviation of a single outer ring width Δ_{Cs}								Radial runout of inner ring/outer ring K_{ia}, K_{ea}				Nominal outside diameter D mm					
		class PK		class PN		class PC		class PB		class PK		class PN		class PC		class PB		class PK	class PN	class PC	class PB						
over	up to	upper	lower	upper	lower	upper	lower	upper	lower	upper	lower	upper	lower	upper	lower	upper	lower	upper	lower	upper	lower	max.	max.	max.	max.	over	up to
18	30	0	-12	0	-12	0	-8	0	-6	0	-150	0	-100	0	-150	0	-150	18	18	5	3	18	18	5	3	18	30
30	50	0	-14	0	-14	0	-9	0	-7	0	-150	0	-100	0	-150	0	-150	20	20	6	3	20	20	6	3	30	50
50	80	0	-16	0	-16	0	-11	0	-9	0	-150	0	-100	0	-150	0	-150	25	25	6	4	25	25	6	4	50	80
80	120	0	-18	0	-18	0	-13	0	-10	0	-200	0	-100	0	-200	0	-200	35	35	6	4	35	35	6	4	80	120
120	150	0	-20	0	-20	0	-15	0	-11	0	-200	0	-100	0	-200	0	-200	40	40	7	4	40	40	7	4	120	150
150	180	0	-25	0	-25	0	-18	0	-13	0	-200	0	-100	0	-250	0	-250	45	45	8	4	45	45	8	4	150	180
180	250	0	-30	0	-30	0	-20	0	-15	0	-250	0	-100	0	-250	0	-250	50	50	10	5	50	50	10	5	180	250
250	315	0	-35	0	-35	0	-25	0	-18	0	-250	0	-100	0	-300	0	-300	60	60	11	5	60	60	11	5	250	315
315	400	0	-40	0	-40	0	-28	-	-	0	-250	0	-100	0	-300	-	-	70	70	13	-	70	70	13	-	315	400

[Note] 1) Bearings with supplementary code "J" attached at the front of bearing number
 Ex. JHM720249/JHM720210, and the like

7. Bearing tolerances

Table 7-9 Tolerances for thrust ball bearings = JIS B 1514-2 =

(1) Shaft race and central race

Unit : μm

Nominal bore diameter of shaft or central race d or d_2 , mm		Single plane mean bore diameter deviation Δ_{dmp} or Δ_{d2mp}				Single plane bore diameter variation V_{dsp} or V_{d2sp}		Race raceway to back face thickness variation $S_i^{1)2)}$			
		classes 0, 6, 5		class 4		classes 0, 6, 5	class 4	class 0	class 6	class 5	class 4
		upper	lower	upper	lower	max.		max.			
over	up to										
-	18	0	- 8	0	- 7	6	5	10	5	3	2
18	30	0	- 10	0	- 8	8	6	10	5	3	2
30	50	0	- 12	0	- 10	9	8	10	6	3	2
50	80	0	- 15	0	- 12	11	9	10	7	4	3
80	120	0	- 20	0	- 15	15	11	15	8	4	3
120	180	0	- 25	0	- 18	19	14	15	9	5	4
180	250	0	- 30	0	- 22	23	17	20	10	5	4
250	315	0	- 35	0	- 25	26	19	25	13	7	5
315	400	0	- 40	0	- 30	30	23	30	15	7	5
400	500	0	- 45	0	- 35	34	26	30	18	9	6
500	630	0	- 50	0	- 40	38	30	35	21	11	7
630	800	0	- 75	0	- 50	55	40	40	25	13	8
800	1 000	0	- 100	-	-	75	-	45	30	15	-
1 000	1 250	0	- 125	-	-	95	-	50	35	18	-

- [Notes] 1) Double direction thrust ball bearings shall be included in d of single direction thrust ball bearings of the same diameter series and nominal outside diameter.
2) Applies only to thrust ball bearings and cylindrical roller thrust bearings with 90° contact angle.

(2) Housing race

Unit : μm

Nominal outside diameter D , mm		Single plane mean outside diameter deviation Δ_{Dmp}				Single plane outside diameter variation V_{Dsp}		Race raceway to back face thickness variation $S_e^{1)2)}$
		classes 0, 6, 5		class 4		classes 0, 6, 5	class 4	
		upper	lower	upper	lower	max.		
over	up to							
10	18	0	- 11	0	- 7	8	5	
18	30	0	- 13	0	- 8	10	6	
30	50	0	- 16	0	- 9	12	7	
50	80	0	- 19	0	- 11	14	8	
80	120	0	- 22	0	- 13	17	10	
120	180	0	- 25	0	- 15	19	11	
180	250	0	- 30	0	- 20	23	15	Shall conform to the tolerance S_i on d or d_2 of the same bearing
250	315	0	- 35	0	- 25	26	19	
315	400	0	- 40	0	- 28	30	21	
400	500	0	- 45	0	- 33	34	25	
500	630	0	- 50	0	- 38	38	29	
630	800	0	- 75	0	- 45	55	34	
800	1 000	0	- 100	0	- 60	75	45	
1 000	1 250	0	- 125	-	-	95	-	
1 250	1 600	0	- 160	-	-	120	-	

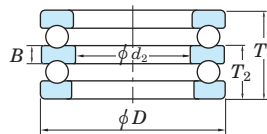
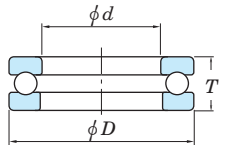

- d : shaft race nominal bore diameter
 d_2 : central race nominal bore diameter
 D : housing race nominal outside diameter
 B : central race nominal height
 T : nominal bearing height (single direction)
 T_1, T_2 : nominal bearing height (double direction)

- [Notes] 1) These shall be applied to race with flat back face only.
2) Applies only to thrust ball bearings and cylindrical roller thrust bearings with 90° contact angle.

(3) Bearing height and central race height

Unit : μm

Nominal bore diameter d , mm		Single direction		Double direction					
		Deviation of the actual bearing height ΔT_s		Deviation of the actual bearing height $\Delta T_{1s}^{1)}$		Deviation of the actual bearing height $\Delta T_{2s}^{1)}$		Deviation of a single central race height B $\Delta B_s^{1)}$	
		class 0		class 0		class 0		class 0	
over	up to	upper	lower	upper	lower	upper	lower	upper	lower
-	30	0	- 75	+ 50	- 150	0	- 75	0	- 50
30	50	0	- 100	+ 75	- 200	0	- 100	0	- 75
50	80	0	- 125	+ 100	- 250	0	- 125	0	- 100
80	120	0	- 150	+ 125	- 300	0	- 150	0	- 125
120	180	0	- 175	+ 150	- 350	0	- 175	0	- 150
180	250	0	- 200	+ 175	- 400	0	- 200	0	- 175
250	315	0	- 225	+ 200	- 450	0	- 225	0	- 200
315	400	0	- 300	+ 250	- 600	0	- 300	0	- 250

- [Note] 1) Double direction thrust ball bearings shall be included in d of single direction thrust ball bearings of the same diameter series and nominal outside diameter.

[Remark] Values in Italics are prescribed in JTEKT standards.

Table 7-10 Tolerances for spherical thrust roller bearings (class 0) = JIS B 1514-2 =

(1) Shaft race

Unit : μm

Nominal bore diameter d , mm		Single plane mean bore diameter deviation Δ_{dmp}		Single plane bore diameter variation V_{dsp} , max.	Refer. Actual bearing height deviation ΔT_s		
		class 0			S_d , max.	upper	lower
		upper	lower				
over	up to						
50	80	0	- 15	11	25	+ 150	- 150
80	120	0	- 20	15	25	+ 200	- 200
120	180	0	- 25	19	30	+ 250	- 250
180	250	0	- 30	23	30	+ 300	- 300
250	315	0	- 35	26	35	+ 350	- 350
315	400	0	- 40	30	40	+ 400	- 400
400	500	0	- 45	34	45	+ 450	- 450

S_d : perpendicularity of inner ring face with respect to the bore

[Remark] Values in Italics are prescribed in JTEKT standards.

(2) Housing race

Unit : μm

Nominal outside diameter D , mm		Single plane mean outside diameter deviation Δ_{Dmp}	
		upper	lower
over	up to		
120	180	0	- 25
180	250	0	- 30
250	315	0	- 35
315	400	0	- 40
400	500	0	- 45
500	630	0	- 50
630	800	0	- 75
800	1 000	0	- 100

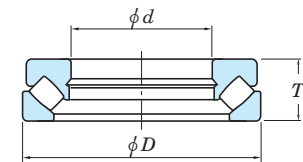

- d : shaft race nominal bore diameter
 D : housing race nominal outside diameter
 T : nominal bearing height

Table 7-11 Tolerances and permissible values for tapered bores of radial bearings

(class 0 ... JIS B 1514-1)

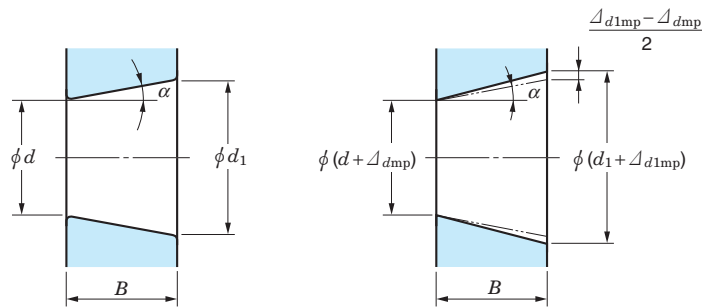

Theoretical tapered bore

Tapered bore with single plane mean bore diameter deviation

(1) Basically tapered bore (taper 1:12) Unit : μm

Nominal bore diameter d, mm		Δ _{dmp}		Δ _{d1mp} - Δ _{dmp}		V _{dsp} ¹⁾
over	up to	upper	lower	upper	lower	max.
-	10	+ 22	0	+ 15	0	9
10	18	+ 27	0	+ 18	0	11
18	30	+ 33	0	+ 21	0	13
30	50	+ 39	0	+ 25	0	16
50	80	+ 46	0	+ 30	0	19
80	120	+ 54	0	+ 35	0	22
120	180	+ 63	0	+ 40	0	40
180	250	+ 72	0	+ 46	0	46
250	315	+ 81	0	+ 52	0	52
315	400	+ 89	0	+ 57	0	57
400	500	+ 97	0	+ 63	0	63
500	630	+ 110	0	+ 70	0	70
630	800	+ 125	0	+ 80	0	-
800	1 000	+ 140	0	+ 90	0	-
1 000	1 250	+ 165	0	+ 105	0	-
1 250	1 600	+ 195	0	+ 125	0	-

(2) Basically tapered bore (taper 1:30) Unit : μm

Nominal bore diameter d, mm		Δ _{dmp}		Δ _{d1mp} - Δ _{dmp}		V _{dsp} ¹⁾
over	up to	upper	lower	upper	lower	max.
-	50	+ 15	0	+ 30	0	19
50	80	+ 15	0	+ 30	0	19
80	120	+ 20	0	+ 35	0	22
120	180	+ 25	0	+ 40	0	40
180	250	+ 30	0	+ 46	0	46
250	315	+ 35	0	+ 52	0	52
315	400	+ 40	0	+ 57	0	57
400	500	+ 45	0	+ 63	0	63
500	630	+ 50	0	+ 70	0	70

[Note] 1) These shall be applied to all radial planes with tapered bore, not be applied to bearings of diameter series 7, 8.

[Remark] 1) Symbols of quantity d₁ : reference diameter at theoretical large end of tapered bore

$$d_1 = d + \frac{1}{12} B \text{ or } d_1 = d + \frac{1}{30} B$$

Δ_{dmp} : single plane mean bore diameter deviation at theoretical small end of tapered bore

Δ_{d1mp} : single plane mean bore diameter deviation at theoretical large end of tapered bore

V_{dsp} : single plane bore diameter variation (a tolerance for the diameter variation given by a maximum value applying in any radial plane of the bore)

B : nominal inner ring width

α : $\frac{1}{2}$ of nominal tapered angle of tapered bore

(tapered ratio 1/12)

(tapered ratio 1/30)

α = 2°23'9.4"

α = 0°57'17.4"

= 2.385 94°

= 0.954 84°

= 0.041 643 rad

= 0.016 665 rad

Table 7-12 Tolerances and permissible values for flanged radial ball bearings

(1) Tolerances on flange outside diameters

Unit : μm

Nominal outer ring flange outside diameter D ₁ (mm)		Deviation of single outer ring flange outside diameter, Δ _{D1s}			
		Locating flange		Non-locating flange	
over	up to	upper	lower	upper	lower
-	6	0	- 36	+ 220	- 36
6	10	0	- 36	+ 220	- 36
10	18	0	- 43	+ 270	- 43
18	30	0	- 52	+ 330	- 52
30	50	0	- 62	+ 390	- 62
50	80	0	- 74	+ 460	- 74

(2) Tolerances and permissible values on flange widths and permissible values of running accuracies relating to flanges

Unit : μm

Nominal outside diameter D (mm)	Deviation of single outer ring flange width Δ _{C1s} ¹⁾	Variation of outer ring flange width V _{C1s} ¹⁾						Perpendicularity of outer ring outside surface with respect to the flange back face S _{D1}			Axial runout of assembled bearing outer ring flange back face S _{ea1}						
				classes 0, 6		class 5	class 4	class 2	Deep groove ball bearings and angular contact ball bearings		Tapered roller bearings		Deep groove ball bearings and angular contact ball bearings		Tapered roller bearings		
		over	up to	upper	lower	max.	max.	max.	max.	max.	max.	max.	max.	max.			
-	2.5	Shall conform to the tolerance Δ _{Bs} on d of the same class and the bearing	Shall conform to the tolerance V _{Bs} on d of the same class and the bearing	5	2.5	1.5	8	4	1.5	8	4	1.5	11	7	3	7	4
2.5	6			5	2.5	1.5	8	4	1.5	8	4	1.5	11	7	3	7	4
6	18			5	2.5	1.5	8	4	1.5	8	4	1.5	11	7	3	7	4
18	30			5	2.5	1.5	8	4	1.5	8	4	1.5	11	7	4	7	4
30	50			5	2.5	1.5	8	4	1.5	8	4	2	11	7	4	7	4
50	80			6	3	1.5	8	4	1.5	8	4	2.5	14	7	6	7	6

[Note] 1) These shall be applied to groove ball bearings, i.e. deep groove ball bearing and angular contact ball bearing etc.

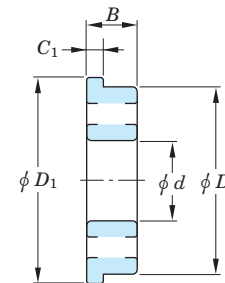

d : nominal bore diameter

D : nominal outside diameter

B : nominal assembled bearing width

D₁ : nominal outer ring flange outside diameter

C₁ : nominal outer ring flange width

7. Bearing tolerances

Table 7-13 Permissible values for chamfer dimensions = JIS B 1514-3 =

(1) Radial bearing

(tapered roller bearings excluded)

Unit : mm

r_{min} or r_{1min}	Nominal bore diameter d mm		r_{max} or r_{1max}	
	over	up to	Radial direction	Axial direction
0.05	-	-	0.1	0.2
0.08	-	-	0.16	0.3
0.1	-	-	0.2	0.4
0.15	-	-	0.3	0.6
0.2	-	-	0.5	0.8
0.3	-	40	0.6	1
	40	-	0.8	1
0.6	-	40	1	2
	40	-	1.3	2
1	-	50	1.5	3
	50	-	1.9	3
1.1	-	120	2	3.5
	120	-	2.5	4
1.5	-	120	2.3	4
	120	-	3	5
2	-	80	3	4.5
	80	220	3.5	5
	220	-	3.8	6
2.1	-	280	4	6.5
	280	-	4.5	7
2.5	-	100	3.8	6
	100	280	4.5	6
	280	-	5	7
3	-	280	5	8
	280	-	5.5	8
4	-	-	6.5	9
5	-	-	8	10
6	-	-	10	13
7.5	-	-	12.5	17
9.5	-	-	15	19
12	-	-	18	24
15	-	-	21	30
19	-	-	25	38

[Remarks]

- Value of r_{max} or r_{1max} in the axial direction of bearings with nominal width lower than 2 mm shall be the same as the value in radial direction.
- There shall be no specification for the accuracy of the shape of the chamfer surface, but its outline in the axial plane shall not be situated outside of the imaginary circle arc with a radius of r_{min} or r_{1min} which contacts the inner ring side face and bore, or the outer ring side face and outside surface.

(2) Radial bearings with locating snap ring (snap ring groove side) and cylindrical roller bearings (separate thrust collar and loose rib side)

Unit : mm

r_{1min}	Nominal bore dia. or nominal outside dia. d or D		r_{1max}	
	over	up to	Radial direction	Axial direction
0.2	-	-	0.5	0.5
0.3	-	40	0.6	0.8
	40	-	0.8	0.8
0.5	-	40	1	1.5
	40	-	1.3	1.5
0.6	-	40	1	1.5
	40	-	1.3	1.5
1	-	50	1.5	2.2
	50	-	1.9	2.2
1.1	-	120	2	2.7
	120	-	2.5	2.7
1.5	-	120	2.3	3.5
	120	-	3	3.5
2	-	80	3	4
	80	220	3.5	4
	220	-	3.8	4
2.1	-	280	4	4.5
	280	-	4.5	4.5
2.5	-	100	3.8	5
	100	280	4.5	5
3	-	280	5	5.5
	280	-	5.5	5.5
4	-	-	6.5	6.5
5	-	-	8	8
6	-	-	10	10

[Remark] There shall be no specification for the accuracy of the shape of the chamfer surface, but its outline in the axial plane shall not be situated outside of the imaginary circle arc with a radius of r_{1min} which contacts the inner ring side face and bore, or the outer ring side face and outside surface.

(3) Cylindrical roller bearings (non-rib side) and angular contact ball bearings (front face side)

Unit : mm

r_{1min}	Nominal bore dia. or nominal outside dia. d or D		r_{1max}	
	over	up to	Radial direction	Axial direction
0.1	-	-	0.2	0.4
0.15	-	-	0.3	0.6
0.2	-	-	0.5	0.8
0.3	-	40	0.6	1
	40	-	0.8	1
0.6	-	40	1	2
	40	-	1.3	2
1	-	50	1.5	3
	50	-	1.9	3
1.1	-	120	2	3.5
	120	-	2.5	4
1.5	-	120	2.3	4
	120	-	3	5
2	-	80	3	4.5
	80	220	3.5	5
	220	-	3.8	6

[Remark] There shall be no specification for the accuracy of the shape of the chamfer surface, but its outline in the axial plane shall not be situated outside of the imaginary circle arc with a radius of r_{1min} which contacts the inner ring side face and bore, or the outer ring side face and outside surface.

(4) Metric series tapered roller bearing

Unit : mm

r_{min} or r_{1min}	Nominal bore dia. or nominal outside dia. ¹⁾ d or D , mm		r_{max} or r_{1max}	
	over	up to	Radial direction	Axial direction
0.3	-	40	0.7	1.4
	40	-	0.9	1.6
0.6	-	40	1.1	1.7
	40	-	1.3	2
1	-	50	1.6	2.5
	50	-	1.9	3
1.5	-	120	2.3	3
	120	250	2.8	3.5
	250	-	3.5	4
2	-	120	2.8	4
	120	250	3.5	4.5
	250	-	4	5
2.5	-	120	3.5	5
	120	250	4	5.5
	250	-	4.5	6
3	-	120	4	5.5
	120	250	4.5	6.5
	250	400	5	7
4	-	120	5	7
	120	250	5.5	7.5
	250	400	6	8
5	-	180	6.5	8
	180	-	7.5	9
6	-	180	7.5	10
	180	-	9	11
7.5	-	-	12.5	17
9.5	-	-	15	19

[Note] 1) Inner ring shall be included in division d , and outer ring, in division D .

[Remarks]

- There shall be no specification for the accuracy of the shape of the chamfer surface, but its outline in the axial plane shall not be situated outside of the imaginary circle arc with a radius of r_{min} or r_{1min} which contacts the inner ring back face and bore, or the outer ring back face and outside surface.
- Values in Italics are provided in JTEKT standards.

(5) Thrust bearing

Unit : mm

r_{min} or r_{1min}	r_{max} or r_{1max}	
	Radial and axial direction	
0.05	0.1	
0.08	0.16	
0.1	0.2	
0.15	0.3	
0.2	0.5	
0.3	0.8	
0.6	1.5	
1	2.2	
1.1	2.7	
1.5	3.5	
2	4	
2.1	4.5	
3	5.5	
4	6.5	
5	8	
6	10	
7.5	12.5	
9.5	15	
12	18	
15	21	
19	25	

[Remark] There shall be no specification for the accuracy of the shape of the chamfer surface, but its outline in the axial plane shall not be situated outside of the imaginary circle arc with a radius of r_{min} or r_{1min} which contacts with the shaft or central race back face and bore, or the housing race back face and outside surface.

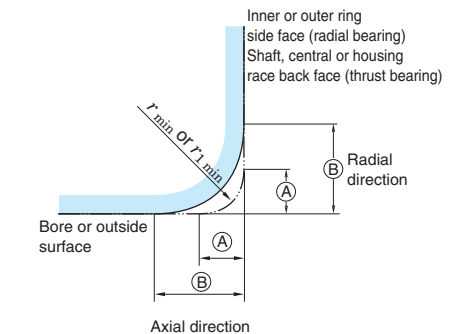

(A) : r_{min} or r_{1min}
(B) : r_{max} or r_{1max}

7-2 Tolerance measuring method (reference)

The details on measuring methods for bearings are prescribed in JIS B 1515-2. This section outlines measuring methods for dimensional and running accuracy.

Dimensional accuracy (1)

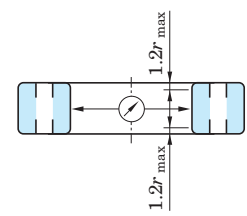
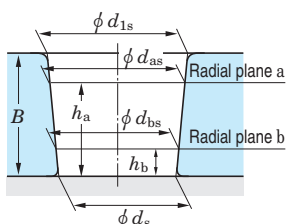
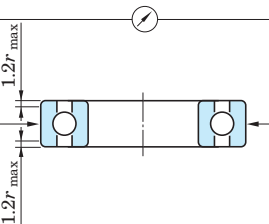
<p>Bore diameter (d) Cylindrical bore bearings</p>	<p>Obtain the maximum value ($d_{sp\ max}$) and the minimum value ($d_{sp\ min}$) of the bore diameter (d_s) acquired in a single radial plane. Obtain the single plane mean bore diameter (d_{mp}) as the arithmetic mean value of the maximum value ($d_{sp\ max}$) and minimum values ($d_{sp\ min}$).</p>  $d_{mp} = \frac{d_{sp\ max} + d_{sp\ min}}{2}$ <p>Single plane mean bore diameter deviation ; $\Delta d_{mp} = d_{mp} - d$ Bore diameter variation in a single plane ; $V_{d_{sp}} = d_{sp\ max} - d_{sp\ min}$ Mean bore diameter variation ; $V_{d_{mp}} = d_{mp\ max} - d_{mp\ min}$ Deviation of a single bore diameter ; $\Delta d_s = d_s - d$</p>
<p>Bore diameter (d) Tapered bore bearings</p>	<p>Bore diameter at the theoretical small end and bore diameter at the theoretical large end ;</p> $d_s = \frac{d_{bs} \cdot h_a - d_{as} \cdot h_b}{h_a - h_b}$ $d_{1s} = \frac{d_{as}(B - h_b) - d_{bs}(B - h_a)}{h_a - h_b}$ <p>Single plane mean bore diameter deviation at the theoretical small end ; $\Delta d_{mp} = d_{mp} - d$ Deviation on taper ; $(\Delta d_{1mp} - \Delta d_{mp}) = (d_{1mp} - d_1) - (d_{mp} - d)$ Bore diameter variation in a single plane ; $V_{d_{sp}} = d_{sp\ max} - d_{sp\ min}$</p> 
<p>Outside diameter (D)</p>	<p>Obtain the single plane mean outside diameter (D_{mp}) as the arithmetical mean value of the maximum value ($D_{sp\ max}$) and the minimum value ($D_{sp\ min}$) of the outside diameters (D_s) acquired in a single radial plane.</p>  $D_{mp} = \frac{D_{sp\ max} + D_{sp\ min}}{2}$ <p>Single plane mean outside diameter deviation ; $\Delta D_{mp} = D_{mp} - D$ Outside diameter variation in a single plane ; $V_{D_{sp}} = D_{sp\ max} - D_{sp\ min}$ Mean outside diameter variation ; $V_{D_{mp}} = D_{mp\ max} - D_{mp\ min}$ Deviation of a single outside diameter ; $\Delta D_s = D_s - D$</p>

Dimensional accuracy (2)

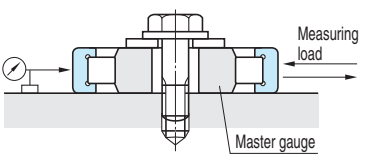
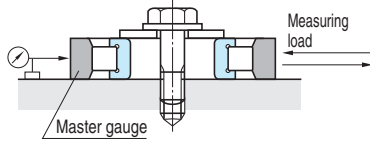
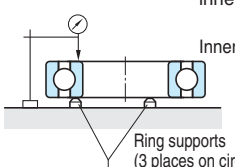
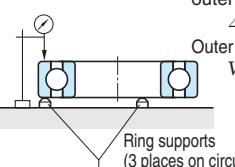
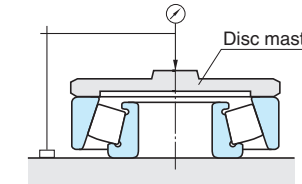
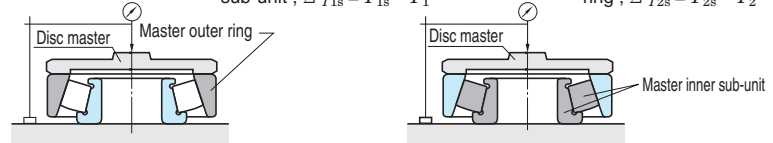
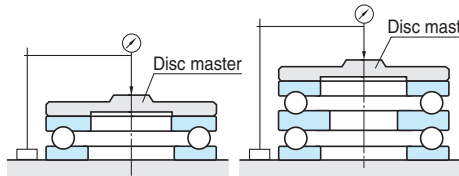
<p>Roller set bore diameter (F_w)</p>	 <p>Deviation of the roller set bore diameter ; $\Delta F_w = (d_G + \delta_{1m}) - F_w$ Deviation of the minimum diameter of the roller set bore diameter ; $\Delta F_{w\ min} = (d_G + \delta_{1min}) - F_w$ (d_G) outside diameter of the master gauge (δ_{1m}) arithmetical mean value of the amount of movement of the outer ring (δ_{1min}) minimum value of the amount of movement of the outer ring</p>	
<p>Roller set outside diameter (E_w)</p>	 <p>Deviation of the roller set outside diameter ; $\Delta E_w = (D_G + \delta_{2m}) - E_w$ (D_G) bore diameter of the master gauge (δ_{2m}) arithmetical mean value of the amount of movement of the master gauge</p>	
<p>Inner ring width (B)</p>	 <p>Deviation of a single inner ring width ; $\Delta B_s = B_s - B$ Inner ring width variation ; $V_{B_s} = B_{s\ max} - B_{s\ min}$</p>	 <p>Deviation of a single outer ring width ; $\Delta C_s = C_s - C$ Outer ring width variation ; $V_{C_s} = C_{s\ max} - C_{s\ min}$</p>
<p>Assembled bearing width of tapered roller bearing (T)</p>	 <p>Deviation of the actual bearing width ; $\Delta T_s = T_s - T$</p>	
<p>Nominal effective width of tapered roller bearing (T_1, T_2)</p>	 <p>Deviation of the actual effective width of inner sub-unit ; $\Delta T_{1s} = T_{1s} - T_1$ Deviation of the actual effective width of outer ring ; $\Delta T_{2s} = T_{2s} - T_2$</p>	
<p>Nominal height of thrust ball bearing with flat back face (T, T1)</p>	 <p>Deviation of the actual bearing height ; $\Delta T_s = T_s - T$ (single direction) $\Delta T_{1s} = T_{1s} - T_1$ (double direction)</p>	

Running accuracy (1)

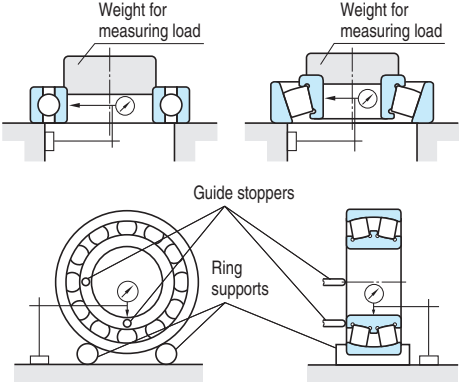
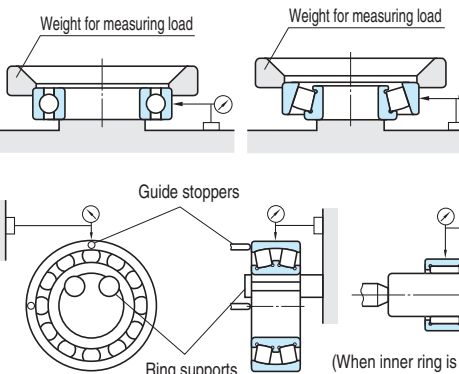
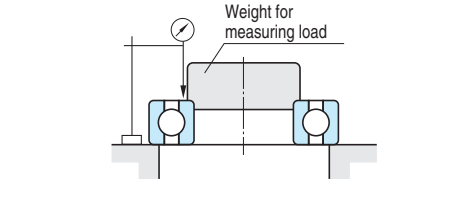
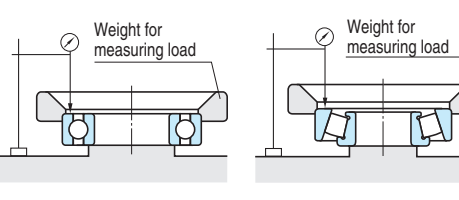
<p>Radial runout of assembled bearing inner ring (K_{ia})</p>		<p>The radial runout of the inner ring (K_{ia}) shall be obtained as the difference between the maximum value and the minimum value of the readings of the measuring instrument, when the inner ring has been rotated through one rotation.</p> <p>[Note] The measurement of the radial runout of the inner ring of cylindrical roller bearings, machined ring needle roller bearings, self-aligning ball bearings and spherical roller bearings shall be carried out by fixing the outer ring with ring supports.</p>
<p>Radial runout of assembled bearing outer ring (K_{ea})</p>		<p>The measurement of outer ring runout (K_{ea}) shall be obtained as the difference between the maximum value and the minimum value of the readings of the measuring instrument, when the outer ring has been rotated through one rotation.</p> <p>[Note] The measurement of the radial runout of the outer ring of cylindrical roller bearings, machined ring needle roller bearings, self-aligning ball bearings and spherical roller bearings shall be carried out by fixing the inner ring with ring supports.</p>
<p>Axial runout of assembled bearing inner ring (S_{ia})</p>		<p>The axial runout of the inner ring (S_{ia}) shall be obtained as the difference between the maximum value and the minimum value of the readings of the measuring instrument, when the inner ring has been rotated through one rotation.</p>
<p>Axial runout of assembled bearing outer ring (S_{ea})</p>		<p>The axial runout of the outer ring (S_{ea}) shall be obtained as the difference between the maximum value and the minimum value of the readings of the measuring instrument, when the outer ring has been rotated through one rotation.</p>

Running accuracy (2)

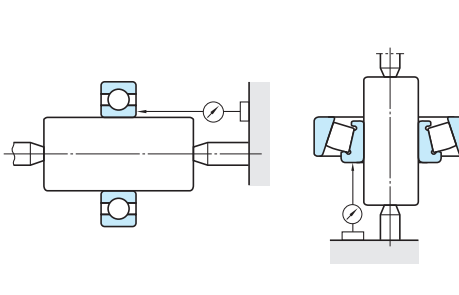
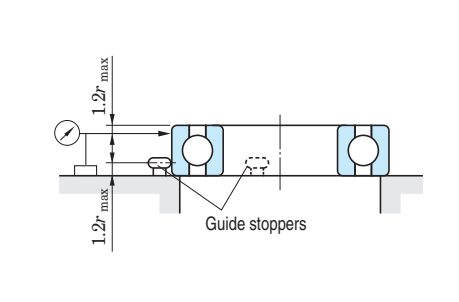
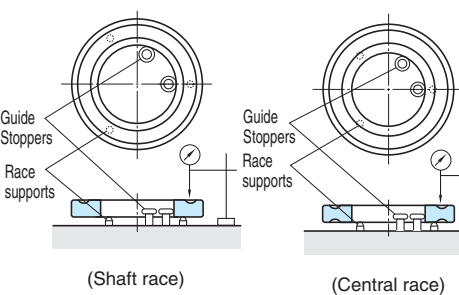
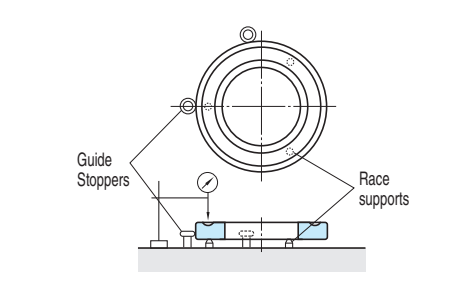
<p>Perpendicularity of inner ring face with respect to the bore (S_d)</p>		<p>Perpendicularity of inner ring face (S_d) shall be obtained as the difference between the maximum value and the minimum value of the readings of the measuring instrument, when the inner ring has been rotated through one rotation with the tapered arbor.</p>
<p>Perpendicularity of outer ring outside surface with respect to the face (S_D)</p>		<p>Perpendicularity of outer ring outside surface (S_D) shall be obtained as the difference between the maximum value and the minimum value of the readings of the measuring instrument, when the outer ring has been rotated through one rotation along the guide stopper.</p>
<p>Shaft/central raceway to back face thickness variation of thrust ball bearing with flat back face (S_i)</p>		<p>The measurement of the thickness variation (S_i) of shaft raceway track shall be obtained as the difference between the maximum value and the minimum value of the readings of the measuring instrument, when the shaft race has been rotated through one rotation along the guide stopper. For the central race, carry out the same measurement for the two raceway grooves to obtain the thickness variation of the raceway track (S_i).</p>
<p>Housing raceway to back face thickness variation of thrust ball bearing with flat back face (S_e)</p>		<p>The measurement of the thickness variation (S_e) of housing raceway track shall be obtained as the difference between the maximum value and the minimum value of the readings of the measuring instrument, when the housing race has been rotated through one rotation along the guide stopper.</p>

8. Limiting speed

The rotational speed of a bearing is normally affected by friction heat generated in the bearing. If the heat exceeds a certain amount, seizure or other failures occur, thus causing rotation to be discontinued.

The limiting speed is the highest speed at which a bearing can continuously operate without generating such critical heat.

The limiting speed differs depending on various factors including bearing type, dimensions and their accuracy, lubrication, lubricant type and amount, shapes of cages and materials and load conditions, etc.

The limiting speed determined under grease lubrication and oil lubrication (oil bath) for each bearing type are listed in the bearing specification table.

These speeds are applied when bearings of standard design are rotated under normal load conditions (approximately, $C/P \geq 16^*$, $F_a / F_r \leq 0.25$).

Each lubricant has superior performance in use, according to type.

Some are not suitable for high speed ; when bearing rotational speed exceeds 80 % of catalog specification, consult with JTEKT.

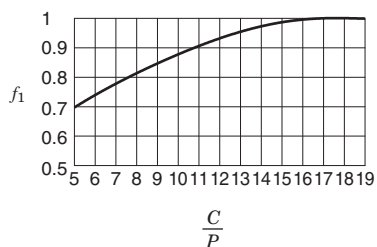

Fig. 8-1a Values of correction coefficient f_1 of load magnitude (Excludes K type bearings and railway rolling stock axle journals)

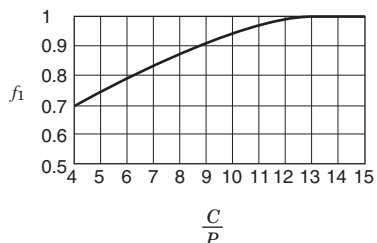

Fig. 8-1b Values of correction coefficient f_1 of load magnitude (K type bearings and railway rolling stock axle journals)

8-1 Correction of limiting speed

When the load condition is $C/P < 16^*$, i.e. the dynamic equivalent load P exceeds approximately 6% of basic dynamic load rating C , or when a combined load in which the axial load is greater than 25 % of radial load is applied, the limiting speed should be corrected by using equation (8-1) :

$$n_a = f_1 \cdot f_2 \cdot n \quad \text{..... (8-1)}$$

where :

- n_a : corrected limiting speed min^{-1}
- f_1 : correction coefficient determined from the load magnitude (Fig. 8-1)
- f_2 : correction coefficient determined from combined load (Fig. 8-2)
- n : limiting speed under normal load condition min^{-1} (values in the bearing specification table)
- C : basic dynamic load rating N
- P : dynamic equivalent load N
- F_r : radial load N
- F_a : axial load N

* 13 (8 %) for K type bearings and railway rolling stock axle journals

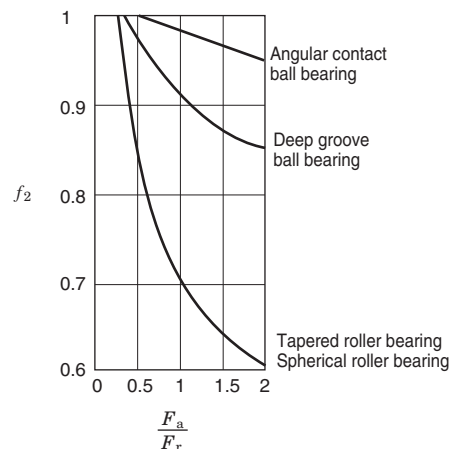

Fig. 8-2 Values of correction coefficient f_2 of combined load

8-2 Limiting speed for sealed ball bearings

The limiting speed of ball bearings with a contact seal (RS, RK type) are determined by the rubbing speed at which the seal contacts the inner ring. These allowable rubbing speeds differ depending on seal rubber materials; and, for ball bearings with the Koyo standard contact type seal (NBR), a rubbing speed of 15 m/s is utilized.

8-3 Considerations for high speed

When bearings are used for high speed, especially when the rotation speed approaches the limiting speed or exceeds it, the following should be considered : (for further information on high speed, consult with JTEKT)

- (1) Use of high precision bearings
- (2) Study of proper internal clearance
 (Reduction in internal clearance caused by temperature increase should be considered.)
- (3) Selection of proper cage type and materials
 (For high speed, copper alloy or phenolic resin machined cages are suitable. Synthetic resin molded cages for high speed are also available.)
- (4) Selection of proper lubrication
 (Suitable lubrication for high speed should be selected jet lubrication, oil mist lubrication and oil air lubrication, etc.)

8-4 Frictional coefficient (reference)

The frictional moment of rolling bearings can be easily compared with that of plain bearings. The frictional moment of rolling bearings can be obtained from their bore diameter, using the following equation :

$$M = \mu P \frac{d}{2} \quad \text{..... (8-2)}$$

where :

- M : frictional moment $\text{mN} \cdot \text{m}$
- μ : frictional coefficient
- P : load on the bearing N
- d : nominal bore diameter mm

The friction coefficient is greatly dependent on bearing type, bearing load, rotation speed and lubrication, etc.

Reference values for the friction coefficient during stable operation under normal operating conditions are listed in Table 8-1.

For plain bearings, the value is normally 0.01 to 0.02 ; but, for certain cases, it is 0.1 to 0.2.

Table 8-1 Friction coefficient μ

Bearing type	Friction coefficient μ
Deep groove ball bearing	0.001 0 – 0.001 5
Angular contact ball bearing	0.001 2 – 0.002 0
Self-aligning ball bearing	0.000 8 – 0.001 2
Cylindrical roller bearing	0.000 8 – 0.001 2
Full complement type needle roller bearing	0.002 5 – 0.003 5
Needle roller and cage assembly	0.002 0 – 0.003 0
Tapered roller bearing	0.001 7 – 0.002 5
Spherical roller bearing	0.002 0 – 0.002 5
Thrust ball bearing	0.001 0 – 0.001 5
Spherical thrust roller bearing	0.002 0 – 0.002 5

9. Bearing fits

9-1 Purpose of fit

The purpose of fit is to securely fix the inner or outer ring to the shaft or housing, to preclude detrimental circumferential sliding on the fitting surface.

Such detrimental sliding (referred to as "creep") will cause abnormal heat generation, wear of the fitting surface, infiltration of abrasion metal particles into the bearing, vibration, and many other harmful effects, which cause a deterioration of bearing functions.

Therefore, it is necessary to fix the bearing ring which is rotating under load to the shaft or housing with interference.

9-2 Tolerance and fit for shaft & housing

For metric series bearings, tolerances for the shaft diameter and housing bore diameter are standardized in JIS B 0401-1 and 0401-2 "ISO system of limits and fits - Part 1 and Part 2" (based on ISO 286; shown in Appendixes at the back of this catalogue). Bearing fits on the shaft and housing are determined based on the tolerances specified in the above standard.

Fig. 9-1 shows the relationship between tolerances for shaft and housing bore diameters and fits for bearings of class 0 tolerance.

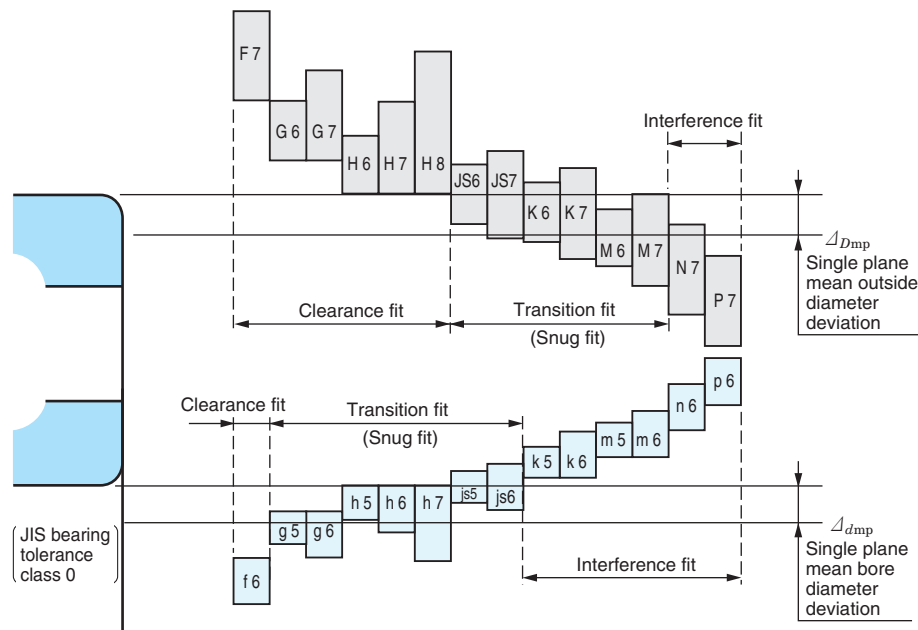

Fig. 9-1 Relationship between tolerances for shaft/housing bore diameters and fits (bearings of class 0 tolerance)

9-3 Fit selection

In selecting the proper fit, careful consideration should be given to bearing operating conditions.

Major specific considerations are :

- Load characteristics and magnitude
- Temperature distribution in operating
- Bearing internal clearance
- Surface finish, material and thickness of shaft and housing
- Mounting and dismounting methods
- Necessity to compensate for shaft thermal expansion at the fitting surface
- Bearing type and size

In view of these considerations, the following paragraphs explain the details of the important factors in fit selection.

1) Load characteristics

Load characteristics are classified into three types : rotating inner ring load; rotating outer ring load and indeterminate direction load.

Table 9-1 tabulates the relationship between these characteristics and fit.

Table 9-1 Load characteristics and fits

Rotation pattern	Direction of load	Loading conditions	Fit		Typical application
			Inner ring & shaft	Outer ring & housing	
<p>Inner ring : rotating Outer ring : stationary</p>	<p>Stationary</p>	Rotating inner ring load	Interference fit necessary	Clearance fit acceptable	Spur gear boxes, motors
<p>Inner ring : stationary Outer ring : rotating</p>	<p>Rotating (with outer ring)</p>	Stationary outer ring load	(k, m, n, p, r)	(F, G, H, JS)	Greatly unbalanced wheels
<p>Inner ring : stationary Outer ring : rotating</p>	<p>Stationary</p>	Stationary inner ring load	Clearance fit acceptable	Interference fit necessary	Running wheels & pulleys with stationary shaft
<p>Inner ring : rotating Outer ring : stationary</p>	<p>Rotating (with inner ring)</p>	Rotating outer ring load	(f, g, h, js)	(K, M, N, P)	Shaker screens (unbalanced vibration)
Indeterminate	Rotating or stationary	Indeterminate direction load	Interference fit	Interference fit	Cranks

2) Effect of load magnitude

When a radial load is applied, the inner ring will expand slightly. Since this expansion enlarges the circumference of the bore minutely, the initial interference is reduced.

The reduction can be calculated by the following equations :

[In the case of $F_r \leq 0.25 C_0$]

$$\Delta_{dF} = 0.08 \sqrt{\frac{d}{B}} \cdot F_r \times 10^{-3} \dots\dots\dots (9-1)$$

[In the case of $F_r > 0.25 C_0$]

$$\Delta_{dF} = 0.02 \frac{F_r}{B} \times 10^{-3} \dots\dots\dots (9-2)$$

where:

- Δ_{dF} : reduction of inner ring interference mm
- d : nominal bore diameter of bearing mm
- B : nominal inner ring width mm
- F_r : radial load N
- C_0 : basic static load rating N

Consequently, when the radial load, exceeds the C_0 value by more than 25 %, greater interference is needed.

Much greater interference is needed, when impact loads are expected.

3) Effect of fitting surface roughness

The effective interference obtained after fitting differs from calculated interference due to plastic deformation of the ring fitting surface.

When the inner ring is fitted, the effective interference, subject to the effect of the fitting surface finish, can be approximated by the following equations :

[In the case of a ground shaft]

$$\Delta_{deff} \doteq \frac{d}{d+2} \Delta_d \dots\dots\dots (9-3)$$

[In the case of a turned shaft]

$$\Delta_{deff} \doteq \frac{d}{d+3} \Delta_d \dots\dots\dots (9-4)$$

where:

- Δ_{deff} : effective interference mm
- Δ_d : calculated interference mm
- d : nominal bore diameter of bearing mm

4) Effect of temperature

A bearing generally has an operating temperature, higher than the ambient temperature. When the inner ring operates under load, its temperature generally becomes higher than that of the shaft and the effective interference decreases due to the greater thermal expansion of the inner ring.

If the assumed temperature difference between the bearing inside and surrounding housing is Δ_t , the temperature difference at the fitting surfaces of the inner ring and shaft will be approximately $(0.10 \text{ to } 0.15) \times \Delta_t$.

The reduction of interference (Δ_{dt}) due to temperature difference is then expressed as follows :

$$\begin{aligned} \Delta_{dt} &= (0.10 \text{ to } 0.15) \Delta_t \cdot \alpha \cdot d \\ &\doteq 0.0015 \Delta_t \cdot d \times 10^{-3} \dots\dots\dots (9-5) \end{aligned}$$

where:

- Δ_{dt} : reduction of interference due to temperature difference mm
- Δ_t : temperature difference between the inside of the bearing and the surrounding housing °C
- α : linear expansion coefficient of bearing steel ($\doteq 12.5 \times 10^{-6}$) 1/°C
- d : nominal bore diameter of bearing mm

Consequently, when a bearing is higher in temperature than the shaft, greater interference is required.

However, a difference in temperature or in the coefficient of expansion may sometimes increase the interference between outer ring and housing. Therefore, when clearance is provided to accommodate shaft thermal expansion, care should be taken.

5) Maximum stress due to fit

When a bearing is fitted with interference, the bearing ring will expand or contract, generating internal stress.

Should this stress be excessive, the bearing ring may fracture.

The maximum bearing fitting-generated stress is determined by the equation in Table 9-2.

In general, to avoid fracture, it is best to adjust the maximum interference to less than 1/1 000 of the shaft diameter, or the maximum stress (σ), determined by the equation in Table 9-2, should be less than 120 MPa.

Table 9-2 Maximum fitting-generated stress in bearings

Shaft & inner ring	Housing bore & outer ring
(In the case of hollow shaft)	(In the case of $D_h \neq \infty$)
$\sigma = \frac{E}{2} \cdot \frac{\Delta_{deff}}{d} \cdot \frac{\left(1 - \frac{d_0^2}{d^2}\right) \left(1 + \frac{d^2}{D_i^2}\right)}{\left(1 - \frac{d_0^2}{D_i^2}\right)}$	$\sigma = E \cdot \frac{\Delta_{Deff}}{D} \cdot \frac{\left(1 - \frac{D^2}{D_h^2}\right)}{\left(1 - \frac{D_e^2}{D_h^2}\right)}$
(In the case of solid shaft)	(In the case of $D_h = \infty$)
$\sigma = \frac{E}{2} \cdot \frac{\Delta_{deff}}{d} \cdot \left(1 + \frac{d^2}{D_i^2}\right)$	$\sigma = E \cdot \frac{\Delta_{Deff}}{D}$

where :

- σ : maximum stress MPa
- d : nominal bore diameter (shaft diameter) mm
- D_i : raceway contact diameter of inner ring mm
 - ball bearing $D_i \doteq 0.2 (D + 4 d)$
 - roller bearing ... $D_i \doteq 0.25 (D + 3 d)$
- Δ_{deff} : effective interference of inner ring mm
- d_0 : bore diameter of hollow shaft mm
- D_e : raceway contact diameter of outer ring mm
 - ball bearing $D_e \doteq 0.2 (4D + d)$
 - roller bearing ... $D_e \doteq 0.25 (3D + d)$
- D : nominal outside diameter (bore diameter of housing) mm
- Δ_{Deff} : effective interference of outer ring mm
- D_h : outside diameter of housing mm
- E : young's modulus 2.08×10^5 MPa

[Remark] The above equations are applicable when the shaft and housing are steel. When other materials are used, JTEKT should be consulted.

6) Other considerations

When a high degree of accuracy is required, the tolerance of the shaft and housing must be improved. Since the housing is generally less easy to machine precisely than the shaft, it is advisable to use a clearance fit on the outer ring.

With hollow shafts or thin section housings, greater than normal interference is needed.

With split housings, on the other hand, smaller interference with outer ring is needed.

When the housing is made of aluminum or other light metal alloy, relatively greater than normal interference is needed.

In such a case, consult with JTEKT.

9-4 Recommended fits

As described in Section 9-3, the characteristics / magnitude of the bearing load, temperature, mounting / dismounting methods and other conditions must be considered to choose proper fits.

Past experience is also valuable. Table 9-3 shows standard fits for the metric series bearings; Tables 9-4 to 9-8 tabulate the most typical and recommended fits for different bearings types.

Table 9-3 Standard fits for metric series bearings¹⁾

(1) Fits for bore diameter²⁾ of radial bearings

Class of bearing	Rotating inner ring load or indeterminate direction load					Stationary inner ring load				
	Class of shaft tolerance range									
Classes 0, 6X, 6	r 6	p 6	n 6	m 6 m 5	k 6 k 5	js 6 js 5	h 5	h 6 h 5	g 6 g 5	f 6
Class 5	-	-	-	m 5	k 4	js 4	h 4	h 5	-	-
Fit	Interference fit					Transition fit			Clearance fit	

(2) Fits for outside diameter²⁾ of radial bearings

Class of bearing	Stationary outer ring load			Indeterminate direction load or rotating outer ring load						
	Class of housing bore tolerance range									
Classes 0, 6X, 6	G 7	H 7 H 6	JS 7 JS 6	-	JS 7 JS 6	K 7 K 6	M 7 M 6	N 7 N 6	P 7	
Class 5	-	H 5	JS 5	K 5	-	K 5	M 5	-	-	
Fit	Clearance fit			Transition fit					Interference fit	

(3) Fits for bore diameter²⁾ of thrust bearings

Class of bearing	Central axial load (generally for thrust bearings)		Combined load (in the case of spherical thrust roller bearing)				
			Rotating shaft race load or indeterminate direction load			Stationary shaft race load	
	Class of shaft tolerance range						
Classes 0, 6	js 6	h 6	n 6	m 6	k 6		js 6
Fit	Transition fit		Interference fit			Transition fit	

(4) Fits for outside diameter²⁾ of thrust bearings

Class of bearing	Central axial load (generally for thrust bearings)		Combined load (in the case of spherical thrust roller bearing)					
			Stationary housing race load or indeterminate direction load			Rotating housing race load		
	Class of housing bore tolerance range							
Classes 0, 6	-	H 8	G 7	H 7	JS 7	K 7		M 7
Fit	Clearance fit				Transition fit			

[Notes] 1) Bearings specified in JIS B 1512
2) Follow JIS B 1514-1 and 1514-2 for tolerance.

Table 9-4 (1) Recommended shaft fits for radial bearings (classes 0, 6X, 6)

Conditions ¹⁾	Ball bearing	Cylindrical roller bearing Tapered roller bearing	Spherical roller bearing		Class of shaft tolerance range	Remarks	Applications (for reference)		
			over	up to					
	Shaft diameter (mm)								
Cylindrical bore bearing (classes 0, 6X, 6)									
Rotating inner ring load or indeterminate direction load	Light load or fluctuating load $\left(\frac{P_r}{C_r} \leq 0.05\right)$	-	18	-	-	h 5	For applications requiring high accuracy, js 5, k 5 and m 5 should be used in place of js 6, k 6 and m 6.	Electric appliances, machine tools, pumps, blowers, carriers etc.	
		18	100	-	40	-			js 6
		100	200	40	140	-			k 6
	Normal load $\left(0.05 < \frac{P_r}{C_r} \leq 0.10\right)$	-	18	-	-	js 5	For single-row tapered roller bearings and angular contact ball bearings, k 5 and m 5 may be replaced by k 6 and m 6, because internal clearance reduction due to fit need not be considered.	Electric motors, turbines, internal combustion engines, wood-working machines etc.	
		18	100	-	40	-			k 5
		100	140	40	100	40			m 5
140		200	100	140	65	100			m 6
200		280	140	200	100	140			n 6
-		-	200	400	140	280			p 6
Heavy load or impact load $\left(\frac{P_r}{C_r} > 0.10\right)$	-	-	50	140	50	100	n 6	Bearings with larger internal clearance than standard are required.	Railway rolling stock axle journals, traction motors
	-	-	140	200	100	140	p 6		
	-	-	200	-	140	200	r 6		
Stationary inner ring load	Inner ring needs to move smoothly on shaft.	All shaft diameters				g 6	For applications requiring high accuracy, g 5 should be used. For large size bearing, f 6 may be used for easier movement.	Stationary shaft wheels	
		Inner ring does not need to move smoothly on shaft.	All shaft diameters				h 6	For applications requiring high accuracy, h 5 should be used.	Tension pulleys, rope sheaves etc.
Central axial load only			All shaft diameters				js 6	-	-
Tapered bore bearing (class 0) (with adapter or withdrawal sleeve)									
All loads	All shaft diameters				h 9/IT 5 ²⁾	For transmission shafts, h 10/IT 7 ²⁾ may be applied.			

[Notes] 1) Light, normal, and heavy loads refer to those with dynamic equivalent radial loads (P_r) of 5 % or lower, over 5 % up to 10 % inclusive, and over 10 % respectively in relation to the basic dynamic radial load rating (C_r) of the bearing concerned.
2) IT 5 and IT 7 mean that shaft roundness tolerance, cylindricity tolerance, and other errors in terms of shape should be within the tolerance range of IT 5 and IT 7, respectively. For numerical values for standard tolerance grades IT 5 and IT 7, refer to supplementary table at end of this catalog.

[Remark] This table is applicable to solid steel shafts.

Table 9-4 (2) Recommended housing fits for radial bearings (classes 0, 6X, 6)

Conditions			Class of housing bore tolerance range	Remarks	Applications (for reference)
Housing	Load type etc. ¹⁾	Outer ring axial displacement ²⁾			
One-piece or split type	Stationary outer ring load	All load types	H 7	G 7 may be applied when a large size bearing is used, or if the temperature difference is large between the outer ring and housing.	Ordinary bearing devices, railway rolling stock axle boxes, power transmission equipment etc.
		Light or normal load	H 8	-	
		High temperature at shaft and inner ring	G 7	F 7 may be applied when a large size bearing is used, or if the temperature difference is large between the outer ring and housing.	Drying cylinders etc.
	One-piece type	Indeterminate direction load	Light or normal load, requiring high running accuracy	K 6	Mainly applied to roller bearings.
Requiring low-noise rotation			JS 6	Mainly applied to ball bearings.	
Light or normal load			H 6	-	
Rotating outer ring load		Normal or heavy load	JS 7	For applications requiring high accuracy, JS 6 and K 6 should be used in place of JS 7 and K 7.	Electric motors, pumps, crankshaft main bearings etc.
		High impact load	M 7	-	Traction motors etc.
		Light or fluctuating load	M 7	-	Conveyor rollers, ropeways, tension pulleys etc.
Rotating outer ring load		Normal or heavy load	N 7	Mainly applied to ball bearings.	Wheel hubs with ball bearings etc.
	Thin section housing, heavy or high impact load	P 7	Mainly applied to roller bearings.	Wheel hubs with roller bearings, bearings for large end of connecting rods etc.	

[Notes] 1) Loads are classified as stated in Note 1) to Table 9-4 (1).

2) Indicating distinction between applications of non-separable bearings permitting and not permitting axial displacement of the outer rings.

[Remarks] 1. This table is applicable to cast iron or steel housings.

2. If only central axial load is applied to the bearing, select such tolerance range class as to provide clearance in the radial direction for outer ring.

Table 9-5 (1) Recommended shaft fits for precision extra-small/miniature ball bearings ($d < 10$ mm)

Unit : μ m

Load type	Bearing tolerance class	Single plane mean bore diameter deviation Δ_{dmp}		Shaft diameter dimensional tolerance		Fit ¹⁾	Applications
		upper	lower	upper	lower		
Rotating inner ring load	Middle/high speed Light or normal load	ABMA 5P JIS class 5	0 -5.1 0 -5	+2.5	-2.5	7.6T - 2.5L 7.5T - 2.5L	Gyro rotors, air cleaners, electric tools, encoders
		ABMA 7P JIS class 4	0 -5.1 0 -4	+2.5	-2.5	7.6T - 2.5L 6.5T - 2.5L	
	Low speed Light load	ABMA 5P JIS class 5	0 -5.1 0 -5	-2.5	-7.5	2.6T - 7.5L 2.5T - 7.5L	Gyro gimbals, synchronizers, servomotors, floppy disc spindles
		ABMA 7P JIS class 4	0 -5.1 0 -4	-2.5	-7.5	2.6T - 7.5L 1.5T - 7.5L	
Rotating outer ring load	Low to high speed Light load	ABMA 5P JIS class 5	0 -5.1 0 -5	-2.5	-7.5	2.6T - 7.5L 2.5T - 7.5L	Pinch rolls, tape guide rollers, linear actuators
		ABMA 7P JIS class 4	0 -5.1 0 -4	-2.5	-7.5	2.6T - 7.5L 1.5T - 7.5L	

[Note] 1) Symbols T and L means interference and clearance respectively.

Table 9-5 (2) Recommended housing fits for precision extra-small/miniature ball bearings ($D \leq 30$ mm)

Unit : μ m

Load type	Bearing tolerance class	Single plane mean outside diameter deviation Δ_{Dmp}		Housing bore diameter dimensional tolerance		Fit ¹⁾	Applications
		upper	lower	upper	lower		
Rotating inner ring load	Middle/high speed Light or normal load	ABMA 5P ABMA 7P	0 -5.1	+5	0	0 - 10.1L	Gyro rotors, air cleaners, electric tools, encoders
		JIS class 5 ²⁾	0 -5 0 -6	+5	0	0 - 10 L 0 - 11 L	
		JIS class 4 ²⁾	0 -4 0 -5	+5	0	0 - 9 L 0 - 10 L	
	Low speed Light load	ABMA 5P ABMA 7P	0 -5.1	+2.5 -2.5	2.5T - 7.6L	Gyro gimbals, synchronizers, servomotors, floppy disc spindles	
		JIS class 5 ²⁾	0 -5 0 -6	+2.5 -2.5	2.5T - 7.5L 2.5T - 8.5L		
		JIS class 4 ²⁾	0 -4 0 -5	+2.5 -2.5	2.5T - 6.5L 2.5T - 7.5L		
Rotating outer ring load	Low to high speed Light load	ABMA 5P ABMA 7P	0 -5.1	+2.5 -2.5	2.5T - 7.6L	Pinch rolls, tape guide rollers	
		JIS class 5 ²⁾	0 -5 0 -6	+2.5 -2.5	2.5T - 7.5L 2.5T - 8.5L		
		JIS class 4 ²⁾	0 -4 0 -5	+2.5 -2.5	2.5T - 6.5L 2.5T - 7.5L		

[Notes] 1) Symbols T and L means interference and clearance respectively.

2) In the columns "single plane mean outside diameter deviation" and "fit" upper row values are applied in the case of $D \leq 18$ mm, lower row values in the case of $18 < D \leq 30$ mm.

Table 9-6 (1) Recommended shaft fits for metric J series tapered roller bearings

■ Bearing tolerance : class PK, class PN

Load type		Nominal bore diameter <i>d</i> mm		Class of shaft tolerance range		Remarks
		over	up to			
Rotating inner ring load	Normal load	10	120	m 6	Generally, bearing internal clearance should be larger than standard.	
		120	500	n 6		
	Heavy load Impact load High speed rotation	10	120	n 6		
		120	180	p 6		
		180	250	r 6		
		250	500	r 7		
Rotating outer ring load	Normal load without impact	80	315	h 6 or g 6	Generally, bearing internal clearance should be larger than standard.	
		10	120	n 6		
	Heavy load Impact load High speed rotation	120	180	p 6		
		180	250	r 6		
		250	500	r 7		

■ Bearing tolerance : class PC, class PB

Load type		Nominal bore diameter <i>d</i> mm		Class of shaft tolerance range		Remarks
				(bearing tolerance class)		
		over	up to	PC	PB	
Rotating inner ring load	Spindles of precision machine tools	10	315	k 5	k 5	Generally, bearing internal clearance should be larger than standard.
		315	500	k 5	-	
	Heavy load Impact load High speed rotation	10	18	m 6	m 5	
		18	50	m 5	m 5	
		50	80	n 5	n 5	
		80	120	n 5	n 4	
		120	180	p 4	p 4	
		180	250	r 4	r 4	
		250	315	r 5	r 4	
		315	500	r 5	-	
Rotating outer ring load	Spindles of precision machine tools	10	315	k 5	k 5	
		315	500	k 5	-	

Table 9-6 (2) Recommended housing fits for metric J series tapered roller bearings

■ Bearing tolerance : class PK, class PN

Load type		Nominal outside diameter <i>D</i> mm		Class of housing bore diameter tolerance range		Remarks
		over	up to			
Rotating inner ring load	Used for free or fixed side	18	315	G 7 F 6	Outer ring is easily displaceable in axial direction.	
	Position of outer ring is adjustable (in axial direction)	315	400	J 7		
		Position of outer ring is not adjustable (in axial direction)	18	400		P 7
Rotating outer ring load	Position of outer ring is not adjustable (in axial direction)	18	120 120 180 180 400	R 7	Outer ring is fixed in axial direction.	

■ Bearing tolerance : class PC, class PB

Load type		Nominal outside diameter <i>D</i> mm		Class of housing bore diameter tolerance range		Remarks
				(bearing tolerance class)		
		over	up to	PC	PB	
Rotating inner ring load	Used for free side	18	315	G 5	G 5	Outer ring is easily displaceable in axial direction.
		315	500	G 5	-	
	Used for fixed side	18	315	H 5	H 4	Outer ring is displaceable in axial direction.
		315	500	H 5	-	
	Position of outer ring is adjustable (in axial direction)	18	120	K 5	K 5	Outer ring is fixed in axial direction.
		120	180	JS 6	JS 6	
180		250	JS 6	JS 5		
Position of outer ring is not adjustable (in axial direction)	250	315	K 5	JS 5		
	315	500	K 5	-		
Position of outer ring is not adjustable (in axial direction)	18	315	N 5	M 5		
	315	500	N 5	-		
Rotating outer ring load	Position of outer ring is not adjustable (in axial direction)	18	250 250 315 315 500	N 6 N 5 N 5	N 5 N 5 -	Outer ring is fixed in axial direction.

Table 9-7 (1) Recommended shaft fits for inch series tapered roller bearings

■ Bearing tolerance : class 4, class 2

Load type	Nominal bore diameter <i>d</i> mm (1/25.4)		Deviation of a single bore diameter Δ_{ds} , μm		Dimensional tolerance of shaft diameter μm		Remarks	
	over	up to	upper	lower	upper	lower		
Rotating inner ring load	Normal load	-	76.2 (3.0)	+13	0	+ 38	+ 25	
		76.2 (3.0)	304.8 (12.0)	+25	0	+ 64	+ 38	
		304.8 (12.0)	609.6 (24.0)	+51	0	+127	+ 76	
		609.6 (24.0)	914.4 (36.0)	+76	0	+190	+114	
Rotating inner ring load	Heavy load Impact load High speed rotation	-	76.2 (3.0)	+13	0	Should be such that average interference stands at 0.000 5 × <i>d</i> (mm)	Generally, bearing internal clearance should be larger than standard.	
		76.2 (3.0)	304.8 (12.0)	+25	0			
		304.8 (12.0)	609.6 (24.0)	+51	0			
Rotating outer ring load	Normal load without impact	-	76.2 (3.0)	+13	0	+ 13	0	
		76.2 (3.0)	304.8 (12.0)	+25	0	+ 25	0	
		304.8 (12.0)	609.6 (24.0)	+51	0	+ 51	0	
Rotating outer ring load	Normal load without impact	-	76.2 (3.0)	+13	0	0	- 13	Inner ring is displaceable in axial direction.
		76.2 (3.0)	304.8 (12.0)	+25	0	0	- 25	
		304.8 (12.0)	609.6 (24.0)	+51	0	0	- 51	
Rotating outer ring load	Heavy load Impact load High speed rotation	-	76.2 (3.0)	+13	0	Should be such that average interference stands at 0.000 5 × <i>d</i> (mm)	Generally, bearing internal clearance should be larger than standard.	
		76.2 (3.0)	304.8 (12.0)	+25	0			
		304.8 (12.0)	609.6 (24.0)	+51	0			

■ Bearing tolerance : class 3, class 0¹⁾

Load type	Nominal bore diameter <i>d</i> mm (1/25.4)		Deviation of a single bore diameter Δ_{ds} , μm		Dimensional tolerance of shaft diameter μm		Remarks	
	over	up to	upper	lower	upper	lower		
Rotating inner ring load	Spindles of precision machine tools	-	76.2 (3.0)	+13	0	+ 30	+ 18	
		76.2 (3.0)	304.8 (12.0)	+13	0	+ 30	+ 18	
		304.8 (12.0)	609.6 (24.0)	+25	0	+ 64	+ 38	
		609.6 (24.0)	914.4 (36.0)	+38	0	+102	+ 64	
Rotating inner ring load	Heavy load Impact load High speed rotation	-	76.2 (3.0)	+13	0	Should be such that average interference stands at 0.000 5 × <i>d</i> (mm)	Generally, bearing internal clearance should be larger than standard.	
		76.2 (3.0)	304.8 (12.0)	+13	0			
		304.8 (12.0)	609.6 (24.0)	+25	0			
Rotating outer ring load	Spindles of precision machine tools	-	76.2 (3.0)	+13	0	+ 30	+ 18	
		76.2 (3.0)	304.8 (12.0)	+13	0	+ 30	+ 18	
		304.8 (12.0)	609.6 (24.0)	+25	0	+ 64	+ 38	

[Note] 1) Class 0 bearing : $d \leq 304.8$ mm

Table 9-7 (2) Recommended housing fits for inch series tapered roller bearings

■ Bearing tolerance : class 4, class 2

Load type	Nominal outside diameter <i>D</i> mm (1/25.4)		Deviation of a single outside diameter Δ_{Ds} , μm		Dimensional tolerance of housing bore diameter μm		Remarks	
	over	up to	upper	lower	upper	lower		
Rotating inner ring load	Used for free or fixed side.	-	76.2 (3.0)	+25	0	+ 76	+ 51	Outer ring is easily displaceable in axial direction.
		76.2 (3.0)	127.0 (5.0)	+25	0	+ 76	+ 51	
		127.0 (5.0)	304.8 (12.0)	+25	0	+ 76	+ 51	
		304.8 (12.0)	609.6 (24.0)	+51	0	+152	+102	
Rotating inner ring load	Position of outer ring is adjustable (in axial direction).	-	76.2 (3.0)	+25	0	+ 25	0	Outer ring is displaceable in axial direction.
		76.2 (3.0)	127.0 (5.0)	+25	0	+ 25	0	
		127.0 (5.0)	304.8 (12.0)	+25	0	+ 51	0	
		304.8 (12.0)	609.6 (24.0)	+51	0	+ 76	+ 25	
Rotating outer ring load	Position of outer ring is not adjustable (in axial direction).	-	76.2 (3.0)	+25	0	- 13	- 38	Outer ring is fixed in axial direction.
		76.2 (3.0)	127.0 (5.0)	+25	0	- 25	- 51	
		127.0 (5.0)	304.8 (12.0)	+25	0	- 25	- 51	
		304.8 (12.0)	609.6 (24.0)	+51	0	- 25	- 76	
Rotating outer ring load	Position of outer ring is not adjustable (in axial direction).	-	76.2 (3.0)	+25	0	- 13	- 38	Outer ring is fixed in axial direction.
		76.2 (3.0)	127.0 (5.0)	+25	0	- 25	- 51	
		127.0 (5.0)	304.8 (12.0)	+25	0	- 25	- 51	
		304.8 (12.0)	609.6 (24.0)	+51	0	- 25	- 76	

■ Bearing tolerance : class 3, class 0¹⁾

Load type	Nominal outside diameter <i>D</i> mm (1/25.4)		Deviation of a single outside diameter Δ_{Ds} , μm		Dimensional tolerance of housing bore diameter μm		Remarks	
	over	up to	upper	lower	upper	lower		
Rotating inner ring load	Used for free side.	-	152.4 (6.0)	+13	0	+ 38	+ 25	Outer ring is easily displaceable in axial direction.
		152.4 (6.0)	304.8 (12.0)	+13	0	+ 38	+ 25	
		304.8 (12.0)	609.6 (24.0)	+25	0	+ 64	+ 38	
		609.6 (24.0)	914.4 (36.0)	+38	0	+ 89	+ 51	
Rotating inner ring load	Used for fixed side.	-	152.4 (6.0)	+13	0	+ 25	+ 13	Outer ring is displaceable in axial direction.
		152.4 (6.0)	304.8 (12.0)	+13	0	+ 25	+ 13	
		304.8 (12.0)	609.6 (24.0)	+25	0	+ 51	+ 25	
		609.6 (24.0)	914.4 (36.0)	+38	0	+ 76	+ 38	
Rotating inner ring load	Position of outer ring is adjustable (in axial direction).	-	152.4 (6.0)	+13	0	+ 13	0	Outer ring is fixed in axial direction.
		152.4 (6.0)	304.8 (12.0)	+13	0	+ 25	0	
		304.8 (12.0)	609.6 (24.0)	+25	0	+ 25	0	
		609.6 (24.0)	914.4 (36.0)	+38	0	+ 38	0	
Rotating outer ring load	Position of outer ring is not adjustable (in axial direction).	-	152.4 (6.0)	+13	0	0	- 13	Outer ring is fixed in axial direction.
		152.4 (6.0)	304.8 (12.0)	+13	0	0	- 25	
		304.8 (12.0)	609.6 (24.0)	+25	0	0	- 25	
		609.6 (24.0)	914.4 (36.0)	+38	0	0	- 38	
Rotating outer ring load	Position of outer ring is not adjustable (in axial direction).	-	152.4 (6.0)	+13	0	- 13	- 25	Outer ring is fixed in axial direction.
		152.4 (6.0)	304.8 (12.0)	+13	0	- 13	- 38	
		304.8 (12.0)	609.6 (24.0)	+25	0	- 13	- 38	
		609.6 (24.0)	914.4 (36.0)	+38	0	- 13	- 51	

[Note] 1) Class 0 bearing : $D \leq 304.8$ mm

Table 9-8 (1) Recommended shaft fits for thrust bearings (classes 0, 6)

Load type	Shaft diameter, mm		Class of shaft tolerance range	Remarks	
	over	up to			
Central axial load (generally for thrust bearings)	All shaft diameters		js 6	h 6 may also be used.	
Combined load (spherical thrust roller bearing)	Stationary shaft race load	All shaft diameters		js 6	
	Rotating shaft race load or indeterminate direction load	–	200	k 6	js 6, k 6 and m 6 may be used in place of k 6, m 6 and n 6, respectively.
		200	400	m 6	
400	–	n 6			

Table 9-8 (2) Recommended housing fits for thrust bearings (classes 0, 6)

Load type	Class of housing bore diameter tolerance range	Remarks	
Central axial load (generally for thrust bearings)	–	Select such tolerance range class as provides clearance in the radial direction for housing race.	
	H 8	In case of thrust ball bearings requiring high accuracy.	
Combined load (spherical thrust roller bearing)	Stationary housing race load	H 7	
	Indeterminate direction load or rotating housing race load	K 7	In case of application under normal operating conditions.
		M 7	In case of comparably large radial load.

[Remark] This table is applicable to cast iron or steel housings.

10. Bearing internal clearance

Bearing internal clearance is defined as the total distance either inner or outer ring can be moved when the other ring is fixed.

If movement is in the radial direction, it is called radial internal clearance; if in the axial direction, axial internal clearance. (Fig. 10-1)

Bearing performance depends greatly upon internal clearance during operation (also referred to as operating clearance); inappropriate clearance results in short rolling fatigue life and generation of heat, noise or vibration.

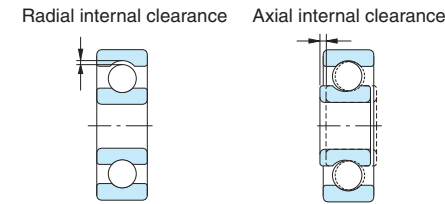

Fig. 10-1 Bearing internal clearance

In measuring internal clearance, a specified load is generally applied in order to obtain stable measurement values.

Consequently, measured clearance values will be larger than the original clearance by the amount of elastic deformation due to the load applied for measurement.

As far as roller bearings are concerned, however, the amount of elastic deformation is negligible.

Clearance prior to mounting is generally defined as the original clearance.

10-1 Selection of internal clearance

The term "residual clearance" is defined as the original clearance decreased owing to expansion or contraction of a raceway due to fitting, when the bearing is mounted in the shaft and housing.

The term "effective clearance" is defined as the residual clearance decreased owing to dimensional change arising from temperature differentials within the bearing.

The term "operating clearance" is defined as the internal clearance present while a bearing mounted in a machine is rotating under a certain load, or, the effective clearance increased due to elastic deformation arising from bearing loads.

As illustrated in Fig. 10-2, bearing fatigue life is longest when the operating clearance is slightly negative.

However, as the operating clearance becomes more negative, the fatigue life shortens remarkably.

Thus it is recommended that bearing internal clearance be selected such that the operating clearance is slightly positive.

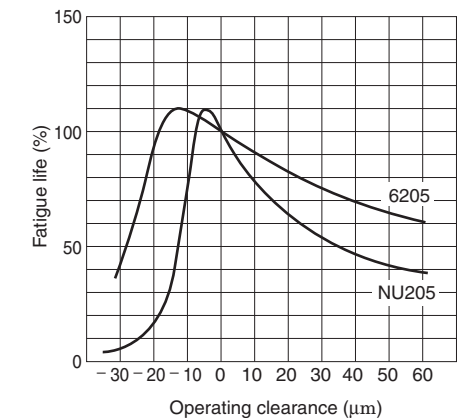

Fig. 10-2 Relationship between operating clearance and fatigue life

It is important to take specific operating conditions into consideration and select a clearance suitable for the conditions.

For example, when high rigidity is required, or when the noise must be minimized, the operating clearance must be reduced. On the other hand, when high operating temperature is expected, the operating clearance must be increased.

10-2 Operating clearance

Table 10-1 shows how to determine the operating clearance when the shaft and housing are made of steel.

Tables 10-2 to 10-10 show standard values for bearing internal clearance before mounting.

Table 10-11 shows examples of clearance selection excluding CN clearance.

Table 10-1 How to determine operating clearance

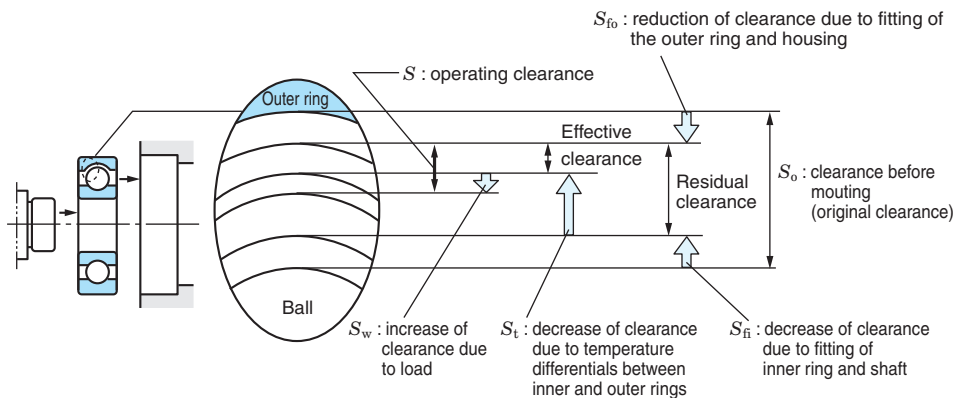

Operating clearance (S)	$S = S_o - (S_f + S_{t1} + S_{t2}) + S_w^*$ <p>* S_w (increase of clearance due to load) is generally small, and thus may be ignored, although there is an equation for determining the value.</p>	
Decrease of clearance due to fitting (S_f)	(In the case of hollow shaft) $S_f = \Delta_{def} \frac{d}{D_i} \cdot \left(1 - \frac{d_0^2}{d^2}\right)$ (In the case of solid shaft) $S_f = \Delta_{def} \frac{d}{D_i}$	(In the case of $D_h \neq \infty$) $S_{fo} = \Delta_{Def} \frac{D_e}{D} \cdot \left(1 - \frac{D^2}{D_h^2}\right)$ (In the case of $D_h = \infty$) $S_{fo} = \Delta_{Def} \frac{D_e}{D}$
Decrease of clearance due to temperature differentials between inner and outer rings (S_{t1})	The amount of decrease varies depending on the state of housing; however, generally the amount can be approximated by the following equation on the assumption that the outer ring will not expand: $S_{t1} = \alpha (D_i \cdot t_i - D_e \cdot t_e)$	
Decrease of clearance due to temperature rise of rolling element (S_{t2})	where: $D_e = D_i + 2D_w$ Consequently, $S_{t1} + S_{t2}$ will be determined by the following equation: $S_{t1} + S_{t2} = \alpha \cdot D_i \cdot t_1 + 2 \alpha \cdot D_w \cdot t_2$ Temperature differential between the inner and outer rings, t_1 , can be expressed as follows: $t_1 = t_i - t_e$ Temperature differential between the rolling element and outer ring, t_2 , can be expressed as follows: $t_2 = t_w - t_e$	

In Table 10-1,

S : operating clearance	mm	Δ_{Def} : effective interference of outer ring	mm
S_o : clearance before mounting	mm	D_h : outside diameter of housing	mm
S_f : decrease of clearance due to fitting	mm	D_e : outer ring raceway contact diameter	mm
S_{fi} : expansion of inner ring raceway contact diameter	mm	(ball bearing $D_e \cong 0.2(4D + d)$	mm
S_{fo} : contraction of outer ring raceway contact diameter	mm	(roller bearing ... $D_e \cong 0.25(3D + d)$)	
S_{t1} : decrease of clearance due to temperature differentials between inner and outer rings	mm	D : nominal outside diameter	mm
S_{t2} : decrease of clearance due to temperature rise of the rolling elements	mm	α : linear expansion coefficient of bearing steel (12.5×10^{-6})	1/°C
S_w : increase of clearance due to load	mm	D_w : average diameter of rolling elements	mm
Δ_{def} : effective interference of inner ring	mm	(ball bearing $D_w \cong 0.3(D - d)$	mm
d : nominal bore diameter (shaft diameter)	mm	(roller bearing ... $D_w \cong 0.25(D - d)$)	
d_0 : bore diameter of hollow shaft	mm	t_i : temperature rise of the inner ring	°C
D_i : inner ring raceway contact diameter	mm	t_e : temperature rise of the outer ring	°C
(ball bearing $D_i \cong 0.2(D + 4d)$	mm	t_w : temperature rise of rolling elements	°C
(roller bearing ... $D_i \cong 0.25(D + 3d)$)			

- Bearings are sometimes used with a non-steel shaft or housing. In the automotive industry, a statistical method is often incorporated for selection of clearance. In these cases, or when other special operating conditions are involved, JTEKT should be consulted.

Table 10-2 Radial internal clearance of deep groove ball bearings (cylindrical bore)

Unit : μm

Nominal bore diameter <i>d</i> , mm		Clearance									
		C 2		C N		C 3		C 4		C 5	
over	up to	min.	max.	min.	max.	min.	max.	min.	max.	min.	max.
2.5	6	0	7	2	13	8	23	<i>14</i>	<i>29</i>	20	37
6	10	0	7	2	13	8	23	14	29	20	37
10	18	0	9	3	18	11	25	18	33	25	45
18	24	0	10	5	20	13	28	20	36	28	48
24	30	1	11	5	20	13	28	23	41	30	53
30	40	1	11	6	20	15	33	28	46	40	64
40	50	1	11	6	23	18	36	30	51	45	73
50	65	1	15	8	28	23	43	38	61	55	90
65	80	1	15	10	30	25	51	46	71	65	105
80	100	1	18	12	36	30	58	53	84	75	120
100	120	2	20	15	41	36	66	61	97	90	140
120	140	2	23	18	48	41	81	71	114	105	160
140	160	2	23	18	53	46	91	81	130	120	180
160	180	2	25	20	61	53	102	91	147	135	200
180	200	2	30	25	71	63	117	107	163	150	230
200	225	2	35	25	85	75	140	125	195	175	265
225	250	2	40	30	95	85	160	145	225	205	300
250	280	2	45	35	105	90	170	155	245	225	340
280	315	2	55	40	115	100	190	175	270	245	370
315	355	3	60	45	125	110	210	195	300	275	410
355	400	3	70	55	145	130	240	225	340	315	460

[Remarks] 1. For measured clearance, the increase of radial internal clearance caused by the measurement load should be added to the values in the above table for correction. Amounts for correction are as shown below.
Of the amounts for clearance correction in the C 2 column, the smaller is applied to the minimum clearance, the larger to the maximum clearance.
2. Values in Italics are prescribed in JTEKT standards.

Nominal bore diameter <i>d</i> , mm		Measurement load N	Amounts of clearance correction, μm				
			C 2	C N	C 3	C 4	C 5
over	up to						
2.5	18	24.5	3 - 4	4	4	4	4
18	50	49	4 - 5	5	6	6	6
50	280	147	6 - 8	8	9	9	9

Table 10-3 Radial internal clearance of extra-small/miniature ball bearings Unit : μm

Clearance code	M 1		M 2		M 3		M 4		M 5		M 6	
	min.	max.	min.	max.	min.	max.	min.	max.	min.	max.	min.	max.
Clearance	0	5	3	8	5	10	8	13	13	20	20	28

[Remark] For measured clearance, the following amounts should be added for correction.

Measurement load, N		Amounts of clearance correction, μm					
Extra-small ball bearing	Miniature ball bearing	M1	M2	M3	M4	M5	M6
2.3		1	1	1	1	1	1

(Extra-small ball bearing : 9 mm or larger in outside diameter and under 10 mm in bore diameter)
(Miniature ball bearing : under 9 mm in outside diameter)

Table 10-4 Axial internal clearance of matched pair angular contact ball bearings (measurement clearance)¹⁾

Unit : μm

Nominal bore diameter <i>d</i> , mm		Contact angle : 15°				Contact angle : 30°							
		C 2		C N		C 2		C N		C 3		C 4	
over	up to	min.	max.	min.	max.	min.	max.	min.	max.	min.	max.	min.	max.
-	10	13	33	33	53	3	14	10	30	30	50	50	70
10	18	15	35	35	55	3	16	10	30	30	50	50	70
18	24	20	40	45	65	3	20	20	40	40	60	60	80
24	30	20	40	45	65	3	20	20	40	40	60	60	80
30	40	20	40	45	65	3	20	25	45	45	65	70	90
40	50	20	40	50	70	3	20	30	50	50	70	75	95
50	65	30	55	65	90	9	27	35	60	60	85	90	115
65	80	30	55	70	95	10	28	40	65	70	95	110	135
80	100	35	60	85	110	10	30	50	75	80	105	130	155
100	120	40	65	100	125	12	37	65	90	100	125	150	175
120	140	45	75	110	140	15	40	75	105	120	150	180	210
140	160	45	75	125	155	15	40	80	110	130	160	210	240
160	180	50	80	140	170	15	45	95	125	140	170	235	265
180	200	50	80	160	190	20	50	110	140	170	200	275	305

Nominal bore diameter <i>d</i> , mm		Contact angle : 40°							
		C 2		C N		C 3		C 4	
over	up to	min.	max.	min.	max.	min.	max.	min.	max.
-	10	2	10	6	18	16	30	26	40
10	18	2	12	7	21	18	32	28	44
18	24	2	12	12	26	20	40	30	50
24	30	2	14	12	26	20	40	40	60
30	40	2	14	12	26	25	45	45	65
40	50	2	14	12	30	30	50	50	70
50	65	5	17	17	35	35	60	60	85
65	80	6	18	18	40	40	65	70	95
80	100	6	20	20	45	55	80	85	110
100	120	6	25	25	50	60	85	100	125
120	140	7	30	30	60	75	105	125	155
140	160	7	30	35	65	85	115	140	170
160	180	7	31	45	75	100	130	155	185
180	200	7	37	60	90	110	140	170	200

[Note] 1) Including increase of clearance caused by measurement load.

10. Bearing internal clearance

Table 10-5 Radial internal clearance of double-row angular contact ball bearings

Unit : μm

Nominal bore diameter <i>d</i> , mm		Clearance					
		CD2		CDN		CD3	
		min.	max.	min.	max.	min.	max.
over	up to						
2.5	10	0	7	2	10	8	18
10	18	0	7	2	11	9	19
18	24	0	8	2	11	10	21
24	30	0	8	2	13	10	23
30	40	0	9	3	14	11	24
40	50	0	10	4	16	13	27
50	65	0	11	6	20	15	30
65	80	0	12	7	22	18	33
80	100	0	12	8	24	22	38
100	120	0	13	9	25	24	42
120	140	0	15	10	26	25	44
140	160	0	16	11	28	26	46
160	180	0	17	12	30	27	47
180	200	0	18	14	32	28	48

[Remark]
Regarding deep groove ball bearings and matched pair and double-row angular contact ball bearings, equations of the relationship between radial internal clearance and axial internal clearance are shown on page A 111.

Table 10-6 Radial internal clearance of self-aligning ball bearings

Unit : μm

Nominal bore diameter <i>d</i> , mm		Cylindrical bore bearing clearance										Tapered bore bearing clearance									
		C 2		C N		C 3		C 4		C 5		C 2		C N		C 3		C 4		C 5	
		min.	max.	min.	max.	min.	max.	min.	max.	min.	max.	min.	max.	min.	max.	min.	max.	min.	max.	min.	max.
2.5	6	1	8	5	15	10	20	15	25	21	33	-	-	-	-	-	-	-	-	-	-
6	10	2	9	6	17	12	25	19	33	27	42	-	-	-	-	-	-	-	-	-	-
10	14	2	10	6	19	13	26	21	35	30	48	-	-	-	-	-	-	-	-	-	-
14	18	3	12	8	21	15	28	23	37	32	50	-	-	-	-	-	-	-	-	-	-
18	24	4	14	10	23	17	30	25	39	34	52	7	17	13	26	20	33	28	42	37	55
24	30	5	16	11	24	19	35	29	46	40	58	9	20	15	28	23	39	33	50	44	62
30	40	6	18	13	29	23	40	34	53	46	66	12	24	19	35	29	46	40	59	52	72
40	50	6	19	14	31	25	44	37	57	50	71	14	27	22	39	33	52	45	65	58	79
50	65	7	21	16	36	30	50	45	69	62	88	18	32	27	47	41	61	56	80	73	99
65	80	8	24	18	40	35	60	54	83	76	108	23	39	35	57	50	75	69	98	91	123
80	100	9	27	22	48	42	70	64	96	89	124	29	47	42	68	62	90	84	116	109	144
100	120	10	31	25	56	50	83	75	114	105	145	35	56	50	81	75	108	100	139	130	170
120	140	10	38	30	68	60	100	90	135	125	175	40	68	60	98	90	130	120	165	155	205
140	160	15	44	35	80	70	120	110	161	150	210	45	74	65	110	100	150	140	191	180	240

Table 10-7 Radial internal clearance of electric motor bearings

1) Deep groove ball bearing Unit : μm

Nominal bore diameter <i>d</i> , mm		Clearance	
		CM	
over	up to	min.	max.
10 ¹⁾	18	4	11
18	30	5	12
30	50	9	17
50	80	12	22
80	120	18	30
120	160	24	38

[Note] 1) 10 mm is included.
[Remark] To adjust for change of clearance due to measuring load, use correction values shown in Table 10-2.

2) Cylindrical roller bearing Unit : μm

Nominal bore diameter <i>d</i> , mm		Clearance			
		Interchangeability CT		Non-interchangeability CM	
		min.	max.	min.	max.
24	40	15	35	15	30
40	50	20	40	20	35
50	65	25	45	25	40
65	80	30	50	30	45
80	100	35	60	35	55
100	120	35	65	35	60
120	140	40	70	40	65
140	160	50	85	50	80
160	180	60	95	60	90
180	200	65	105	65	100

[Note] "Interchangeability" means interchangeable only among products (sub-units) of the same manufacturer ; not with others.

10. Bearing internal clearance

Table 10-8 Radial internal clearance of cylindrical roller bearings and machined ring needle roller bearings

(1) Cylindrical bore bearing

Unit : μm

Nominal bore diameter d , mm		Clearance									
		C 2		C N		C 3		C 4		C 5	
over	up to	min.	max.	min.	max.	min.	max.	min.	max.	min.	max.
-	10	0	25	20	45	35	60	50	75	-	-
10	24	0	25	20	45	35	60	50	75	65	90
24	30	0	25	20	45	35	60	50	75	70	95
30	40	5	30	25	50	45	70	60	85	80	105
40	50	5	35	30	60	50	80	70	100	95	125
50	65	10	40	40	70	60	90	80	110	110	140
65	80	10	45	40	75	65	100	90	125	130	165
80	100	15	50	50	85	75	110	105	140	155	190
100	120	15	55	50	90	85	125	125	165	180	220
120	140	15	60	60	105	100	145	145	190	200	245
140	160	20	70	70	120	115	165	165	215	225	275
160	180	25	75	75	125	120	170	170	220	250	300
180	200	35	90	90	145	140	195	195	250	275	330
200	225	45	105	105	165	160	220	220	280	305	365
225	250	45	110	110	175	170	235	235	300	330	395
250	280	55	125	125	195	190	260	260	330	370	440
280	315	55	130	130	205	200	275	275	350	410	485
315	355	65	145	145	225	225	305	305	385	455	535
355	400	100	190	190	280	280	370	370	460	510	600
400	450	110	210	210	310	310	410	410	510	565	665
450	500	110	220	220	330	330	440	440	550	625	735

(2) Tapered bore bearing

Unit : μm

Nominal bore diameter d , mm		Non-interchangeable clearance													
		C 9 NA ¹⁾		C 1 NA		C 2 NA		C N NA		C 3 NA		C 4 NA		C 5 NA	
over	up to	min.	max.	min.	max.	min.	max.	min.	max.	min.	max.	min.	max.	min.	max.
12	14	5	10	-	-	-	-	-	-	-	-	-	-	-	-
14	24	5	10	10	20	20	30	35	45	45	55	55	65	75	85
24	30	5	10	10	25	25	35	40	50	50	60	60	70	80	95
30	40	5	12	12	25	25	40	45	55	55	70	70	80	95	110
40	50	5	15	15	30	30	45	50	65	65	80	80	95	110	125
50	65	5	15	15	35	35	50	55	75	75	90	90	110	130	150
65	80	10	20	20	40	40	60	70	90	90	110	110	130	150	170
80	100	10	25	25	45	45	70	80	105	105	125	125	150	180	205
100	120	10	25	25	50	50	80	95	120	120	145	145	170	205	230
120	140	15	30	30	60	60	90	105	135	135	160	160	190	230	260
140	160	15	35	35	65	65	100	115	150	150	180	180	215	260	295
160	180	15	35	35	75	75	110	125	165	165	200	200	240	285	320
180	200	20	40	40	80	80	120	140	180	180	220	220	260	315	355
200	225	20	45	45	90	90	135	155	200	200	240	240	285	350	395
225	250	25	50	50	100	100	150	170	215	215	265	265	315	380	430
250	280	25	55	55	110	110	165	185	240	240	295	295	350	420	475
280	315	30	60	60	120	120	180	205	265	265	325	325	385	470	530
315	355	30	65	65	135	135	200	225	295	295	360	360	430	520	585
355	400	35	75	75	150	150	225	255	330	330	405	405	480	585	660
400	450	45	85	85	170	170	255	285	370	370	455	455	540	650	735
450	500	50	95	95	190	190	285	315	410	410	505	505	600	720	815

[Note] 1) Clearance C 9 NA is applied to tapered bore cylindrical roller bearings of JIS tolerance classes 5 and 4.

10. Bearing internal clearance

Table 10-9 Radial internal clearance of spherical roller bearings

(1) Cylindrical bore bearing

Unit : μm

Nominal bore diameter d , mm		Clearance									
		C 2		C N		C 3		C 4		C 5	
over	up to	min.	max.	min.	max.	min.	max.	min.	max.	min.	max.
14	18	10	20	20	35	35	45	45	60	60	75
18	24	10	20	20	35	35	45	45	60	60	75
24	30	15	25	25	40	40	55	55	75	75	95
30	40	15	30	30	45	45	60	60	80	80	100
40	50	20	35	35	55	55	75	75	100	100	125
50	65	20	40	40	65	65	90	90	120	120	150
65	80	30	50	50	80	80	110	110	145	145	180
80	100	35	60	60	100	100	135	135	180	180	225
100	120	40	75	75	120	120	160	160	210	210	260
120	140	50	95	95	145	145	190	190	240	240	300
140	160	60	110	110	170	170	220	220	280	280	350
160	180	65	120	120	180	180	240	240	310	310	390
180	200	70	130	130	200	200	260	260	340	340	430
200	225	80	140	140	220	220	290	290	380	380	470
225	250	90	150	150	240	240	320	320	420	420	520
250	280	100	170	170	260	260	350	350	460	460	570
280	315	110	190	190	280	280	370	370	500	500	630
315	355	120	200	200	310	310	410	410	550	550	690
355	400	130	220	220	340	340	450	450	600	600	750
400	450	140	240	240	370	370	500	500	660	660	820
450	500	140	260	260	410	410	550	550	720	720	900
500	560	150	280	280	440	440	600	600	780	780	1 000
560	630	170	310	310	480	480	650	650	850	850	1 100
630	710	190	350	350	530	530	700	700	920	920	1 190
710	800	210	390	390	580	580	770	770	1 010	1 010	1 300
800	900	230	430	430	650	650	860	860	1 120	1 120	1 440
900	1 000	260	480	480	710	710	930	930	1 220	1 220	1 570

(2) Tapered bore bearing

Unit : μm

Nominal bore diameter d , mm		Clearance									
		C 2		C N		C 3		C 4		C 5	
over	up to	min.	max.	min.	max.	min.	max.	min.	max.	min.	max.
18	24	15	25	25	35	35	45	45	60	60	75
24	30	20	30	30	40	40	55	55	75	75	95
30	40	25	35	35	50	50	65	65	85	85	105
40	50	30	45	45	60	60	80	80	100	100	130
50	65	40	55	55	75	75	95	95	120	120	160
65	80	50	70	70	95	95	120	120	150	150	200
80	100	55	80	80	110	110	140	140	180	180	230
100	120	65	100	100	135	135	170	170	220	220	280
120	140	80	120	120	160	160	200	200	260	260	330
140	160	90	130	130	180	180	230	230	300	300	380
160	180	100	140	140	200	200	260	260	340	340	430
180	200	110	160	160	220	220	290	290	370	370	470
200	225	120	180	180	250	250	320	320	410	410	520
225	250	140	200	200	270	270	350	350	450	450	570
250	280	150	220	220	300	300	390	390	490	490	620
280	315	170	240	240	330	330	430	430	540	540	680
315	355	190	270	270	360	360	470	470	590	590	740
355	400	210	300	300	400	400	520	520	650	650	820
400	450	230	330	330	440	440	570	570	720	720	910
450	500	260	370	370	490	490	630	630	790	790	1 000
500	560	290	410	410	540	540	680	680	870	870	1 100
560	630	320	460	460	600	600	760	760	980	980	1 230
630	710	350	510	510	670	670	850	850	1 090	1 090	1 360
710	800	390	570	570	750	750	960	960	1 220	1 220	1 500
800	900	440	640	640	840	840	1 070	1 070	1 370	1 370	1 690
900	1 000	490	710	710	930	930	1 190	1 190	1 520	1 520	1 860

Table 10-10 Radial internal clearance of double/four-row and matched pair tapered roller bearings (cylindrical bore)

Unit : μm

Nominal bore diameter d , mm		Clearance									
		C 1		C 2		C N		C 3		C 4	
over	up to	min.	max.	min.	max.	min.	max.	min.	max.	min.	max.
14	18	0	10	10	20	20	30	30	40	40	50
18	24	0	10	10	20	20	30	30	40	40	55
24	30	0	10	10	20	20	30	30	45	45	60
30	40	0	12	12	25	25	40	40	55	55	75
40	50	0	15	15	30	30	45	45	60	60	80
50	65	0	15	15	30	30	50	50	70	70	90
65	80	0	20	20	40	40	60	60	80	80	110
80	100	0	20	20	45	45	70	70	100	100	130
100	120	0	25	25	50	50	80	80	110	110	150
120	140	0	30	30	60	60	90	90	120	120	170
140	160	0	30	30	65	65	100	100	140	140	190
160	180	0	35	35	70	70	110	110	150	150	210
180	200	0	40	40	80	80	120	120	170	170	230
200	225	0	40	40	90	90	140	140	190	190	260
225	250	0	50	50	100	100	150	150	210	210	290
250	280	0	50	50	110	110	170	170	230	230	320
280	315	0	60	60	120	120	180	180	250	250	350
315	355	0	70	70	140	140	210	210	280	280	390
355	400	0	70	70	150	150	230	230	310	310	440
400	450	0	80	80	170	170	260	260	350	350	490
450	500	0	90	90	190	190	290	290	390	390	540
500	560	0	100	100	210	210	320	320	430	430	590
560	630	0	110	110	230	230	350	350	480	480	660
630	710	0	130	130	260	260	400	400	540	540	740
710	800	0	140	140	290	290	450	450	610	610	830
800	900	0	160	160	330	330	500	500	670	670	920

Table 10-11 Examples of non-standard clearance selection

Service conditions	Applications	Examples of clearance selection
In the case of heavy/impact load, large interference	Railway rolling stock axle journals	C 3
In the case of vibration/impact load, interference fit both for inner/outer rings	Shaker screens, railway rolling stock traction motors, tractor final reduction gears	C 3, C 4 C 4 C 4
When shaft deflection is large	Automobile rear wheels	C 5
When shaft and inner ring are heated	Dryers of paper making machines, table rollers of rolling mills	C 3, C 4 C 3
When clearance fit both for inner/outer rings	Roll necks of rolling mills	C 2
When noise/vibration during rotation is to be lowered	Micro-motors	C 1, C 2, CM
When clearance after mounting is to be adjusted in order to reduce shaft runout	Lathe spindles	C 9 NA, C 1 NA

[Reference] Relationship between radial internal clearance and axial internal clearance

[Deep groove ball bearing] $\Delta_a = \sqrt{\Delta_r (4m_o - \Delta_r)}$ (10-1)

[Double-row angular contact ball bearing] $\Delta_a = 2\sqrt{m_o^2 - (m_o \cos \alpha - \frac{\Delta_r}{2})^2} - 2m_o \sin \alpha$ (10-2)

[Matched pair angular contact ball bearing] $\Delta_a = 2m_o \sin \alpha - 2\sqrt{m_o^2 - (m_o \cos \alpha + \frac{\Delta_r}{2})^2}$ (10-3)

[Double/four-row and matched pair tapered roller bearing] $\Delta_a = \Delta_r \cot \alpha \div \frac{1.5}{e} \Delta_r$ (10-4)

where :

Δ_a : axial internal clearance mm

Δ_r : radial internal clearance mm

$m_o = r_e + r_i - D_w$

r_e : outer ring raceway groove radius mm
 r_i : inner ring raceway groove radius mm
 D_w : ball diameter mm

α : nominal contact angle

e : limit value of F_a/F_r

(shown in the bearing specification table.)

11. Preload

Generally, bearings are operated with a certain amount of proper clearance allowed. For some applications, however, bearings are mounted with axial load of such magnitude that the clearance will be negative.

The axial load, referred to as "preload," is often applied to angular contact ball bearings and tapered roller bearings.

11-1 Purpose of preload

- To improve running accuracy by reducing runout of shaft, as well as to heighten position accuracy in radial and axial directions. (Bearings for machine tool spindles and measuring instruments)
- To improve gear engagement accuracy by increasing bearing rigidity. (Bearings for automobile final reduction gears)
- To reduce smearing by eliminating sliding in irregular rotation, self-rotation, and around-the-raceway revolution of rolling elements. (For high rotation-speed angular contact ball bearings)
- To minimize abnormal noise due to vibration or resonance. (For small electric motor bearings)
- To keep rolling elements in the right position relative to the raceway. (For thrust ball bearings and spherical thrust roller bearings used on horizontal shafts)

11-2 Method of preloading

The preload can be done either by the position preloading or the constant pressure preloading; typical examples are given in Table 11-1.

(Comparison between position and constant pressure preloadings)

- With the same amount of preloading, the position preloading produces smaller displacement in the axial direction, and thus is liable to bring about higher rigidity.
- The constant pressure preloading produces stable preloading, or little fluctuation in the amount of preload, since the spring can absorb the load fluctuation and shaft expansion/contraction caused by temperature difference between the shaft and housing during operation.
- The position preloading can apply a larger preload.

Consequently, the position preloading is more suitable for applications requiring high rigidity, while the constant pressure preloading is more suitable for high rotational speed, vibration prevention in the axial direction, and thrust bearings used on horizontal shafts.

11-3 Preload and rigidity

For angular contact ball bearings and tapered roller bearings, the "back-to-back" arrangement is generally used to apply preload for higher rigidity.

This is because shaft rigidity is improved by the longer distance between load centers in the back-to-back arrangement.

Fig. 11-1 shows the relationship between preload given via position preloading and rigidity expressed by displacement in the axial direction of the back-to-back bearing.

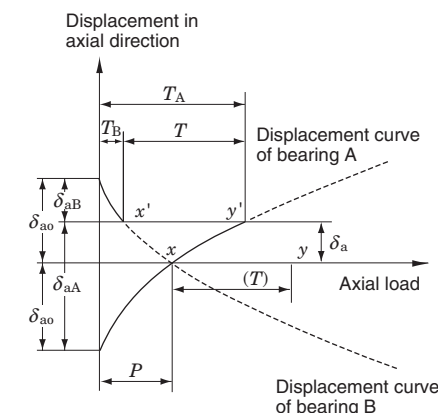
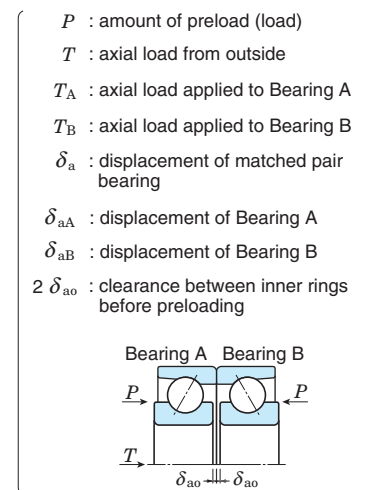

Fig. 11-1 Preloading diagram in position preloading

In Fig. 11-1, when preload P is applied (inner ring is tightened toward the axial direction), bearings A and B are displaced by δ_{a0} respectively, and the clearance between inner rings diminishes from $2\delta_{a0}$ to zero.

The displacement when axial load T is applied to these matched pair bearings from the outside can be determined as δ_a .

[For reference]

How to determine δ_a in Fig. 11-1

- ① Determine the displacement curve of bearing A.
- ② Determine the displacement curve of bearing B. ...Symmetrical curve in relation to horizontal axis intersecting vertical line of preload P at point x .
- ③ With the load from outside defined as T , determine line segment $x-y$ on the horizontal line passing through point x . Displace segment $x-y$ in parallel along the displacement curve of bearing B. Determine point y' at which to intersect displacement curve of bearing A.
- ④ δ_a can be determined as the distance between line segments $x'-y'$ and $x-y$.

Fig. 11-2 shows the relationship between preload and rigidity in the constant pressure preloading using the same matched pair bearings as in Fig. 11-1.

In this case, since the spring rigidity can be ignored, the matched pair bearing shows almost the same rigidity as a separate bearing with preload P applied in advance.

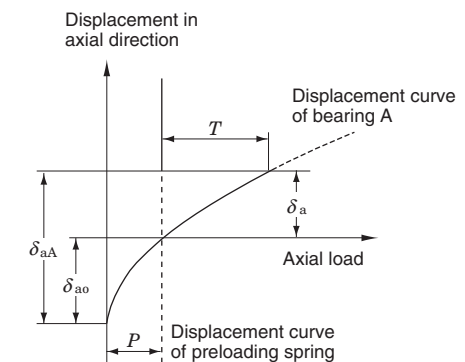

Fig. 11-2 Preloading diagram in constant pressure preloading

Table 11-1 Method of preloading

Position preloading		Constant pressure preloading	
<ul style="list-style-type: none"> ● Method using matched pair bearing with stand-out adjusted for preloading (see below). 	<ul style="list-style-type: none"> ● Method using spacer with dimensions adjusted for preloading. 	<ul style="list-style-type: none"> ● Method using nut or bolt capable of adjusting preload in axial direction. <p>(In this case, starting friction moment during adjustment should be measured so that proper preload will be applied.)</p>	<ul style="list-style-type: none"> ● Method using coil spring or diaphragm spring.

11-4 Amount of preload

The amount of preload should be determined, to avoid an adverse effect on bearing life, temperature rise, friction torque, or other performance characteristic, in view of the bearing application.

Decrease of preload due to wear-in, accuracy of the shaft and housing, mounting conditions, and lubrication should also be fully considered in determining preload.

11-4-1 Preload amount of matched pair angular contact ball bearings

Table 11-2 shows recommended preload for matched pair angular contact ball bearings of JIS class 5 or higher used for machine tool spindles or other higher precision applications.

JTEKT offers four types of standard preload: slight preload (S), light preload (L), medium preload (M), and heavy preload (H), so that preload can be selected properly and easily for various applications.

Generally, light or medium preload is recommended for grinder spindles, and medium or heavy preload for spindles of lathes and milling machines.

Table 11-3 shows recommended fits of high-precision matched pair angular contact ball bearings used with light or medium preload applied.

Table 11-3 Recommended fits for high-precision matched pair angular contact ball bearings with preload applied

(1) Dimensional tolerance of shaft Unit : μm

Shaft diameter mm	Inner ring rotation Tolerance of shaft diameter	Interference between shaft and inner ring (matching adjustment) ¹⁾	Outer ring rotation Tolerance of shaft diameter
6	10	-2 -6	0-2 -4
10	18	-2 -7	0-2 -5
18	30	-2 -8	0-2.5 -6
30	50	-2 -9	0-2.5 -7
50	80	-2 -10	0-3 -8
80	120	-2 -12	0-4 -10
120	180	-2 -14	0-5 -12

(2) Dimensional tolerance of housing bore Unit : μm

Housing bore diameter mm	Inner ring rotation Tolerance of housing bore diameter	Clearance between housing and outer ring ¹⁾	Outer ring rotation Tolerance of housing bore diameter	
				Fixed-side bearing
over	up to			
18	30	± 4.5	+9 0 2-6	-6 -12
30	50	± 5.5	+11 0 2-6	-6 -13
50	80	± 6.5	+13 0 3-8	-8 -16
80	120	± 7.5	+15 0 3-9	-9 -19
120	180	± 9	+18 0 4-12	-11 -23
180	250	± 10	+20 0 5-15	-13 -27
250	315	± 11.5	+23 0 6-18	-16 -32

[Note] 1) Matching adjustment means to measure of bore diameter the bearing and match it to the measured shaft diameter.

[Note] 1) Lower value is desirable for fixed side; higher value for free side.

Table 11-2 Standard preload of high-precision matched pair angular contact ball bearings

[S : slight preload, L : light preload, M : medium preload, H : heavy preload] Unit : N

Bore diameter No.	7900 C			7000			7000 C				7200				7200 C				ACT 000		ACT 000 B		Bore diameter No.
	S	L	M	L	M	H	S	L	M	H	L	M	H	S	L	M	H	L	M	L	M		
00	5	15	30	30	80	145	6	20	50	100	50	145	245	10	30	80	145	-	-	-	-	00	
01	7	20	40	30	80	145	6	20	50	100	60	145	295	15	40	100	195	-	-	-	-	01	
02	8	25	50	50	145	245	10	30	80	145	80	245	390	15	50	145	245	-	-	-	-	02	
03	8	25	50	60	145	295	15	40	100	165	100	245	540	25	70	145	345	-	-	-	-	03	
04	15	40	80	60	145	295	15	40	100	245	145	295	635	25	80	195	390	-	-	-	-	04	
05	15	50	100	100	245	490	20	60	145	295	145	390	785	35	100	245	490	-	-	-	-	05	
06	15	50	100	145	295	635	25	80	195	390	145	590	930	35	100	295	590	195	345	295	685	06	
07	25	70	140	145	390	785	35	100	245	490	245	785	1 270	50	145	390	785	195	390	390	735	07	
08	25	80	155	145	390	785	35	100	295	590	390	880	1 570	65	195	440	880	245	440	440	835	08	
09	35	100	195	245	540	980	50	145	345	635	490	1 080	1 770	85	245	540	1 080	245	490	490	930	09	
10	35	100	195	245	635	1 180	50	145	390	735	540	1 180	2 060	85	245	590	1 180	295	540	540	1 030	10	
11	40	120	235	295	785	1 370	65	195	440	880	635	1 370	2 450	100	295	735	1 470	390	685	685	1 270	11	
12	40	120	235	390	880	1 570	65	195	490	980	785	1 470	2 940	115	345	785	1 670	390	735	735	1 420	12	
13	50	145	295	440	980	1 770	85	245	540	1 090	835	1 670	3 330	130	390	930	1 860	440	835	785	1 520	13	
14	65	195	390	490	1 080	2 060	85	245	635	1 270	930	1 860	3 720	160	490	980	2 060	590	1 130	1 030	2 010	14	
15	65	195	390	590	1 180	2 150	100	295	685	1 370	980	2 150	3 920	195	590	1 180	2 350	590	1 130	1 080	2 110	15	
16	65	195	390	635	1 370	2 350	100	295	735	1 470	1 080	2 450	4 310	225	685	1 370	2 750	685	1 370	1 270	2 500	16	
17	85	245	490	735	1 570	2 550	130	390	880	1 770	1 270	2 940	4 900	260	785	1 570	2 940	735	1 420	1 320	2 600	17	
18	100	295	590	785	1 670	2 840	145	440	980	1 960	1 470	3 230	5 390	260	785	1 770	3 430	980	1 860	1 770	3 380	18	
19	100	295	590	880	1 770	3 140	160	490	1 080	2 060	1 670	3 430	5 880	290	880	1 960	3 920	980	1 960	1 860	3 530	19	
20	100	345	685	880	1 960	3 530	175	540	1 180	2 150	1 860	3 920	6 370	325	980	2 150	4 410	1 030	2 010	1 910	3 680	20	
21	100	345	685	980	2 150	3 920	195	590	1 270	2 350	2 060	4 310	7 060	360	1 080	2 350	4 900	1 180	2 250	2 150	3 770	21	
22	145	390	785	1 080	2 380	4 410	210	635	1 470	2 550	2 250	4 900	7 840	385	1 180	2 450	5 290	1 320	2 600	2 450	4 760	22	
24	145	490	980	1 180	2 650	4 900	225	685	1 670	2 840	2 450	5 390	8 820	420	1 270	2 840	5 490	1 420	2 800	2 550	5 100	24	
26	195	590	1 180	1 370	3 140	5 390	245	735	1 770	3 140	2 750	5 880	9 310	485	1 470	3 140	5 880	1 770	3 380	3 230	6 230	26	
28	195	635	1 270	1 470	3 430	5 880	260	785	1 960	3 920	2 940	6 370	9 800	520	1 570	3 430	6 370	2 010	3 920	3 720	7 210	28	
30	245	735	1 470	1 770	3 920	6 860	275	835	2 150	4 410	3 330	6 860	10 300	585	1 770	3 720	6 860	2 500	4 850	4 660	8 920	30	
32	245	785	1 570	2 150	4 410	7 840	290	880	2 350	4 900	3 630	7 350	10 800	645	1 960	4 120	7 840	2 500	4 850	4 660	8 920	32	
34	345	880	1 810	2 450	4 900	8 820	325	980	2 450	5 390	3 920	7 840	11 800	645	2 150	4 410	8 330	3 090	6 030	5 730	11 100	34	

11-4-2 Amount of preload for thrust ball bearings

When a thrust ball bearing is rotated at high speed, balls slide on raceway due to centrifugal force and the gyro moment, which often causes the raceway to suffer from smearing or other defects.

To eliminate such sliding, it is necessary to mount the bearing without clearance, and apply an axial load (preload) larger than the minimum necessary axial load determined by the following equation.

When an axial load from the outside is lower than $0.0013 C_{0a}$, there is no adverse effect on the bearing, as long as lubrication is satisfactory.

Generally, deep groove and angular contact ball bearings are recommended for applications when a portion of rotation under axial load is present at high speed.

- Thrust ball bearing (contact angle : 90°)

$$F_{a \min} = 5.1 \left(\frac{n}{1000} \right)^2 \cdot \left(\frac{C_{0a}}{1000} \right)^2 \times 10^{-3} \quad (11-1)$$

- Spherical thrust roller bearing (the higher value determined by the two equations should be taken.)

$$F_{a \min} = \frac{C_{0a}}{2000} \quad (11-2)$$

$$F_{a \min} = 1.8F_r + 1.33 \left(\frac{n}{1000} \right)^2 \cdot \left(\frac{C_{0a}}{1000} \right)^2 \times 10^{-4} \quad (11-3)$$

where :

$F_{a \min}$: minimum necessary axial load	N
n : rotational speed	min^{-1}
C_{0a} : static axial load rating	N
F_r : radial load	N

11-4-3 Amount of preload for spherical thrust roller bearings

Spherical thrust roller bearings sometimes suffer from scuffing, smearing, or other defects due to sliding which occurs between the roller and raceway surface in operation.

To eliminate such sliding, it is necessary to mount the bearing without clearance, and apply an axial load (preload) larger than the minimum necessary axial load.

Of the two values determined by the two equations below, the higher should be defined as the minimum necessary axial load.

12. Bearing lubrication

12-1 Purpose and method of lubrication

Lubrication is one of the most important factors determining bearing performance. The suitability of the lubricant and lubrication method have a dominant influence on bearing life.

Functions of lubrication :

- To lubricate each part of the bearing, and to reduce friction and wear
- To carry away heat generated inside bearing due to friction and other causes
- To cover rolling contact surface with the proper oil film in order to prolong bearing fatigue life
- To prevent corrosion and contamination by dirt

Bearing lubrication is classified broadly into two categories: grease lubrication and oil lubrication. Table 12-1 makes a general comparison between the two.

Table 12-1 Comparison between grease and oil lubrication

Item	Grease	Oil
• Sealing device	Easy	Slightly complicated and special care required for maintenance
• Lubricating ability	Good	Excellent
• Rotation speed	Low/medium speed	Applicable at high speed as well
• Replacement of lubricant	Slightly troublesome	Easy
• Life of lubricant	Relatively short	Long
• Cooling effect	No cooling effect	Good (circulation is necessary)
• Filtration of dirt	Difficult	Easy

12-1-1 Grease lubrication

Grease lubrication is widely applied since there is no need for replenishment over a long period once grease is filled, and a relatively simple structure can suffice for the lubricant sealing device.

There are two methods of grease lubrication. One is the closed lubrication method, in which grease is filled in advance into shielded/sealed bearing; the other is the feeding method, in which the bearing and housing are filled with grease in proper quantities at first, and refilled at a regular interval via replenishment or replacement.

Devices with numerous grease inlets sometimes employ the centralized lubricating method, in which the inlets are connected via piping and supplied with grease collectively.

1) Amount of grease

In general, grease should fill approximately one-third to one-half the inside space, though this varies according to structure and inside space of housing.

It must be borne in mind that excessive grease will generate heat when churned, and will consequently alter, deteriorate, or soften.

When the bearing is operated at low speed, however, the inside space is sometimes filled with grease to two-thirds to full, in order to preclude infiltration of contaminants.

2) Replenishment/replacement of grease

The method of replenishing/replacing grease depends largely on the lubrication method. Whichever method may be utilized, care should be taken to use clean grease and to keep dirt or other foreign matter out of the housing.

In addition, it is desirable to refill with grease of the same brand as that filled at the start.

When grease is refilled, new grease must be injected inside bearing.

Fig. 12-1 gives one example of a feeding method.

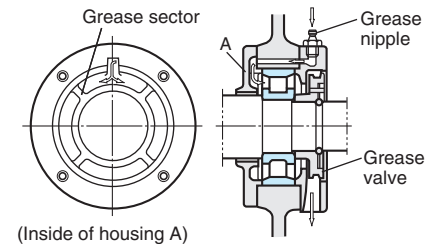

Fig. 12-1 Example of grease feeding method (using grease sector)

In the example, the inside of the housing is divided by grease sectors. Grease fills one sector, then flows into the bearing.

On the other hand, grease flowing back from the inside is forced out of the bearing by the centrifugal force of the grease valve.

When the grease valve is not used, it is necessary to enlarge the housing space on the discharge side to store old grease.

The housing is uncovered and the stored old grease is removed at regular intervals.

3) Grease feeding interval

In normal operation, grease life should be regarded roughly as shown in Fig. 12-2, and replenishment/replacement should be carried out accordingly.

4) Grease life in shielded/sealed ball bearing

Grease life can be estimated by the following equation when a single-row deep groove ball bearing is filled with grease and sealed with shields or seals.

$$\log L = 6.10 - 4.40 \times 10^{-6} d_m n - 3.125 \left(\frac{P_r}{C_r} - 0.04 \right) - (0.021 - 1.80 \times 10^{-6} d_m n) T \quad (12-1)$$

where :

L : grease life h

$d_m = \frac{D+d}{2}$ (D : outside diameter, d : bore diameter) mm

n : rotational speed min⁻¹

P_r : dynamic equivalent radial load N

C_r : basic dynamic radial load rating N

T : operating temperature of bearing °C

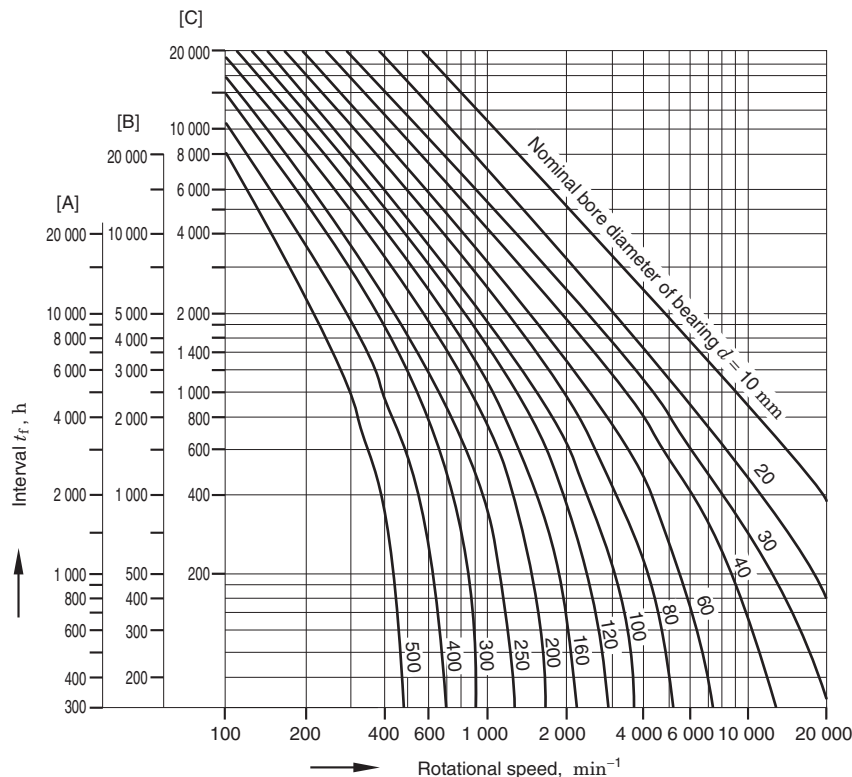

[Notes] 1) [A] : radial ball bearing

[B] : cylindrical roller bearing, needle roller bearing

[C] : tapered roller bearing, spherical roller bearing, thrust ball bearing

2) Temperature correction

When the bearing operating temperature exceeds 70°C, t_f' , obtained by multiplying t_f by correction coefficient a , found on the scale below, should be applied as the feeding interval.

$$t_f' = t_f \times a$$

Temperature correction coefficient a

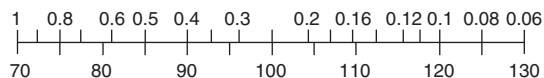

Fig. 12-2 Grease feeding interval

The conditions for applying equation (12-1) are as follows :

a) Operating temperature of bearing : T °C

Applicable when $T \leq 120$

(when $T < 50$,)
 $T = 50$

When $T > 120$, please contact with JTEKT.

c) Load condition : $\frac{P_r}{C_r}$

Applicable when $\frac{P_r}{C_r} \leq 0.16$

(when $\frac{P_r}{C_r} < 0.04$,)
 $\frac{P_r}{C_r} = 0.04$

When $\frac{P_r}{C_r} > 0.16$, please contact with JTEKT.

b) Value of $d_m n$

Applicable when $d_m n \leq 500 \times 10^3$

(when $d_m n < 125 \times 10^3$,)
 $d_m n = 125 \times 10^3$

When $d_m n > 500 \times 10^3$, please contact with JTEKT.

12-1-2 Oil lubrication

Oil lubrication is usable even at high speed rotation and somewhat high temperature, and is effective in reducing bearing vibration and noise.

Thus oil lubrication is used in many cases where grease lubrication does not work.

Table 12-2 shows major types and methods of oil lubrication.

Table 12-2 Type and method of oil lubrication

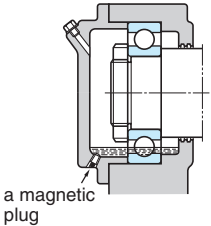
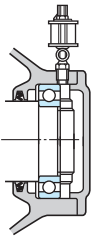
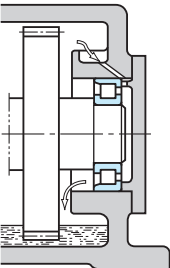
<p>① Oil bath</p>	<ul style="list-style-type: none"> • Simplest method of bearing immersion in oil for operation. • Suitable for low/medium speed. • Oil level gauge should be furnished to adjust the amount of oil. (In the case of horizontal shaft) About 50 % of the lowest rolling element should be immersed. (In the case of vertical shaft) About 70 to 80 % of the bearing should be immersed. • It is better to use a magnetic plug to prevent wear iron particles from dispersing in oil. 	 <p>a magnetic plug</p>
<p>② Oil drip</p>	<ul style="list-style-type: none"> • Oil is dripped with an oiling device, and the inside of the housing is filled with oil mist by the action of rotating parts. This method has a cooling effect. • Applicable at relatively high speed and up to medium load. • In general, 5 to 6 drops of oil are utilized per minute. (It is difficult to adjust the dripping in 1mL/h or smaller amounts.) • It is necessary to prevent too much oil from being accumulated at the bottom of housing. 	
<p>③ Oil splash</p>	<ul style="list-style-type: none"> • This type of lubrication method makes use of a gear or simple flinger attached to shaft in order to splash oil. This method can supply oil for bearings located away from the oil tank. • Usable up to relatively high speed. • It is necessary to keep oil level within a certain range. • It is better to use a magnetic plug to prevent wear iron particles from dispersing in oil. It is also advisable to set up a shield or baffle board to prevent contaminants from entering the bearing. 	

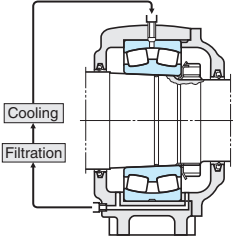
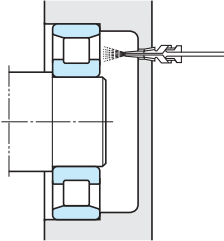
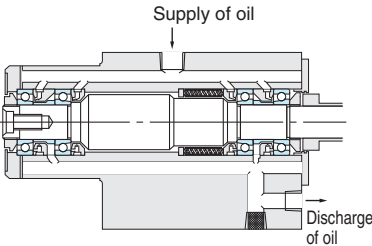
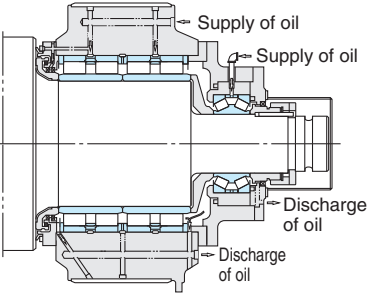
<p>④ Forced oil circulation</p>	<ul style="list-style-type: none"> • This method employs a circulation-type oil supply system. Supplied oil lubricates inside of the bearing, is cooled and sent back to the tank through an oil escape pipe. The oil, after filtering and cooling, is pumped back. • Widely used at high speeds and high temperature conditions. • It is better to use an oil escape pipe approximately twice as thick as the oil supply pipe in order to prevent too much lubricant from gathering in housing. • Required amount of oil : see Remark 1. 	
<p>⑤ Oil jet lubrication</p>	<ul style="list-style-type: none"> • This method uses a nozzle to jet oil at a constant pressure (0.1 to 0.5MPa), and is highly effective in cooling. • Suitable for high speed and heavy load. • Generally, the nozzle (diameter 0.5 to 2 mm) is located 5 to 10 mm from the side of a bearing. When a large amount of heat is generated, 2 to 4 nozzles should be used. • Since a large amount of oil is supplied in the jet lubrication method, old should be discharged with an oil pump to prevent excessive residual oil. • Required amount of oil : see Remark 1. 	
<p>⑥ Oil mist lubrication (spray lubrication)</p>	<ul style="list-style-type: none"> • This method employs an oil mist generator to produce dry mist (air containing oil in the form of mist). The dry mist is continuously sent to the oil supplier, where the mist is turned into a wet mist (sticky oil drops) by a nozzle set up on the housing or bearing, and is then sprayed onto bearing. • Required amount of mist : see Remark 2. <p>(Example of grinding machine)</p> 	<ul style="list-style-type: none"> • This method provides and sustains the smallest amount of oil film necessary for lubrication, and has the advantages of preventing oil contamination, simplifying bearing maintenance, prolonging bearing fatigue life, reducing oil consumption etc. <p>(Example of rolling mill)</p> 

7
Oil/air lubrication

- A proportioning pump sends forth a small quantity of oil, which is mixed with compressed air by a mixing valve. The admixture is supplied continuously and stably to the bearing.
- This method enables quantitative control of oil in extremely small amounts, always supplying new lubricating oil. It is thus suitable for machine tools and other applications requiring high speed.
- Compressed air and lubricating oil are supplied to the spindle, increasing the internal pressure and helping prevent dirt, cutting-liquid, etc. from entering. As well, this method allows the lubricating oil to flow through a feeding pipe, minimizing atmospheric pollution.
- JTEKT produces an oil/air lubricator and, air cleaner, as well as a spindle unit incorporating the oil/air lubrication system. Please refer to brochure "oil/air lubricator & air clean unit".

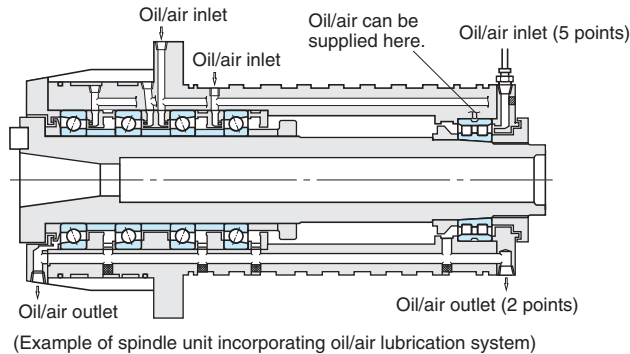

Remark 1 Required oil supply in forced oil circulation ; oil jet lubrication methods

$$G = \frac{1.88 \times 10^{-4} \mu \cdot d \cdot n \cdot P}{60 \cdot c \cdot r \cdot \Delta T}$$

- where :
- G : required oil supply L/min
 - μ : friction coefficient (see table at right)
 - d : nominal bore diameter mm
 - n : rotational speed min^{-1}
 - P : dynamic equivalent load of bearing N
 - c : specific heat of oil 1.88-2.09kJ/kg·K
 - r : density of oil g/cm^3
 - ΔT : temperature rise of oil K

Values of friction coefficient μ

Bearing type	μ
Deep groove ball bearing	0.001 0 – 0.001 5
Angular contact ball bearing	0.001 2 – 0.002 0
Cylindrical roller bearing	0.000 8 – 0.001 2
Tapered roller bearing	0.001 7 – 0.002 5
Spherical roller bearing	0.002 0 – 0.002 5

The values obtained by the above equation show quantities of oil required to carry away all the generated heat, with heat release not taken into consideration.

In reality, the oil supplied is generally half to two-thirds of the calculated value.

Heat release varies widely according to the application and operating conditions.

To determine the optimum oil supply, it is advised to start operating with two-thirds of the calculated value, and then reduce the oil gradually while measuring the operating temperature of bearing, as well as the supplied and discharged oil.

Remark 2 Notes on oil mist lubrication

- 1) Required amount of mist (mist pressure : 5 kPa)

$$Q = 0.11dR$$

(In the case of a bearing)

$$Q = 0.028d_1$$

(In the case of two oil seals combined)

- where :
- Q : required amount of mist L/min
 - d : nominal bore diameter mm
 - R : number of rolling element rows
 - d_1 : inside diameter of oil seal mm

In the case of high speed ($d_m n \geq 400 \times 10^3$), it is necessary to increase the amount of oil and heighten the mist pressure.

- 2) Piping diameter and design of lubrication hole/groove

When the flow rate of mist in piping exceeds 5 m/s, oil mist suddenly condenses into an oil liquid.

Consequently, the piping diameter and dimensions of the lubrication hole/groove in the housing should be designed to keep the flow rate of mist, obtained by the following equation, from exceeding 5 m/s.

$$V = \frac{0.167Q}{A} \leq 5$$

- where :
- V : flow rate of mist m/s
 - Q : amount of mist L/min
 - A : sectional area of piping or lubrication groove cm^2

- 3) Mist oil

Oil used in oil mist lubrication should meet the following requirements.

- ability to turn into mist
- has high extreme pressure resistance
- good heat/oxidation stability
- rust-resistant
- unlikely to generate sludge
- superior demulsifier

Oil mist lubrication has a number of advantages for high speed rotation bearings. Its performance, however, is largely affected by surrounding structures and bearing operating conditions.

If contemplating the use of this method, please contact with JTEKT for advice based on JTEKT long experience with oil mist lubrication.

12-2 Lubricant

12-2-1 Grease

Grease is made by mixing and dispersing a solid of high oil-affinity (called a thickener) with lubricant oil (as a base), and transforming it into a semi-solid state.

As well, a variety of additives can be added to improve specific performance.

(1) Base oil

Mineral oil is usually used as the base oil for grease. When low temperature fluidity, high temperature stability, or other special performance is required, diester oil, silicon oil, polyglycolic oil, fluorinated oil, or other synthetic oil is often used.

Generally, grease with a low viscosity base oil is suitable for applications at low temperature or high rotation speed; grease with high viscosity base oils are suitable for applications at high temperature or under heavy load.

(2) Thickener

Most greases use a metallic soap base such as lithium, sodium, or calcium as thickeners. For some applications, however, non-soap base thickeners (inorganic substances such as bentone, silica gel, and organic substances such as urea compounds, fluorine compounds) are also used.

In general, the mechanical stability, bearing operating temperature range, water resistance, and other characteristics of grease are determined by the thickener.

(Lithium soap base grease)

Superior in heat resistance, water resistance and mechanical stability.

(Calcium soap base grease)

Superior in water resistance; inferior in heat resistance.

(Sodium soap base grease)

Superior in heat resistance; inferior in water resistance.

(Non-soap base grease)

Superior in heat resistance.

(3) Additives

Various additives are selectively used to serve the respective purposes of grease applications.

• Extreme pressure agents

When bearings must tolerate heavy or impact loads.

• Oxidation inhibitors

When grease is not refilled for a long period.

Structure stabilizers, rust preventives, and corrosion inhibitors are also used.

(4) Consistency

Consistency, which indicates grease hardness, is expressed as a figure obtained, in accordance with ASTM (JIS), by multiplication by 10 the depth (in mm) to which the cone-shaped metallic plunger penetrates into the grease at 25°C by deadweight in 5 seconds. The softer the grease, the higher the figure.

Table 12-4 shows the relationships between the NLGI scales and ASTM (JIS) penetration indexes, service conditions of grease.

(NLGI : National Lubricating Grease Institute)

Table 12-4 Grease consistency

NLGI scale	ASTM (JIS) penetration index (25°C, 60 mixing operations)	Service conditions/ applications
0	355 - 385	For centralized lubricating
1	310 - 340	For centralized lubricating, at low temperature
2	265 - 295	For general use
3	220 - 250	For general use, at high temperature
4	175 - 205	For special applications

(5) Mixing of different greases

Since mixing of different greases changes their properties, greases of different brands should not be mixed.

If mixing cannot be avoided, greases containing the same thickener should be used. Even if the mixed greases contain the same thickener, however, mixing may still produce adverse effects, due to difference in additives or other factors.

Thus it is necessary to check the effects of a mixture in advance, through testing or other methods.

Table 12-3 Characteristics of respective greases

	Lithium grease			Calcium grease (cup grease)	Sodium grease (fiber grease)		Complex base grease		Non-soap base grease			
	Thickener	Lithium soap			Calcium soap		Sodium soap	Lithium complex soap	Calcium complex soap	Bentone	Urea compounds	
Base oil	Mineral oil	Synthetic oil (diester oil)	Synthetic oil (silicon oil)	Mineral oil	Mineral oil		Mineral oil	Mineral oil	Mineral oil	Mineral/ synthetic oil	Synthetic oil	Base oil
Dropping point (°C)	170 to 190	170 to 230	220 to 260	80 to 100	160 to 180		250 or higher	200 to 280	-	240 or higher	250 or higher	Dropping point (°C)
Operating temperature range (°C)	- 30 to + 120	- 50 to + 130	- 50 to + 180	- 10 to + 70	0 to + 110		- 30 to + 150	- 10 to + 130	- 10 to + 150	- 30 to + 150	- 40 to + 250	Operating temperature range (°C)
Rotation speed range	Medium to high	High	Low to medium	Low to medium	Low to high		Low to high	Low to medium	Medium to high	Low to high	Low to medium	Rotation speed range
Mechanical stability	Excellent	Good to excellent	Good	Fair to good	Good to excellent		Good to excellent	Good	Good	Good to excellent	Good	Mechanical stability
Water resistance	Good	Good	Good	Good	Bad		Good to excellent	Good	Good	Good to excellent	Good	Water resistance
Pressure resistance	Good	Fair	Bad to fair	Fair	Good to excellent		Good	Good	Good to excellent	Good to excellent	Good	Pressure resistance
Remarks	Most widely usable for various rolling bearings.	Superior low temperature and friction characteristics. Suitable for bearings for measuring instruments and extra-small ball bearings for small electric motors.	Superior high and low temperature characteristics.	Suitable for applications at low rotation speed and under light load. Not applicable at high temperature.	Liable to emulsify in the presence of water. Used at relatively high temperature.		Superior mechanical stability and heat resistance. Used at relatively high temperature.	Superior pressure resistance when extreme pressure agent is added. Used in bearings for rolling mills.	Suitable for applications at high temperature and under relatively heavy load.	Superior water resistance, oxidation stability, and heat stability. Suitable for applications at high temperature and high speed.	Superior chemical resistance and solvent resistance. Usable at up to 250 °C.	Remarks

Table 12-5 Typical examples of standard grease for JTEKT bearings

Grease name	Thickener	Base oil	Appearance	Consistency 60W		NLGI scale	Operating temperature range (°C)	Application examples	
				Unworked	Worked				
Alvania 2	Lithium	Mineral oil	Grayish brown	276	275	2	-10 - 100	Automobile	Steering column
Raremax AF-I	Urea	Mineral oil	Pale yellow, viscous	-	300	1 - 2 ²⁾	0 - 150		Wheel (hub unit)
FS841	Fluororesin	Fluorosilicone oil	White	-	290	2	-40 - 220		Fan coupling
Sunlight 2	Lithium	Mineral oil	Yellowish brown	-	280	2	-10 - 100		Universal joint (shell type), steering joint
Unirex N3	Lithium complex	Mineral oil	Green	-	235	3	-10 - 130		Clutch release
W191	Urea	PAO ¹⁾ , mineral oil	Pale yellow	247	275	2	-30 - 130		Water pump bearing
Darina 2	Microgel	Mineral oil	Amber	-	280	2	0 - 150	Steel production	Conveyor
Emalube L	Urea	Mineral oil	Light brown, viscous	-	350	0 - 1 ²⁾	-10 - 200		Continuous casting machine
Palmax RBG	Special lithium complex	Mineral oil	Yellow, viscous	-	300	1 - 2 ²⁾	-10 - 150		Rolling mill roll neck
4B grease	Carbon black	Ethyl oil	Black	-	260	2 - 3 ²⁾	-30 - 250	Extra-small/miniature ball bearings	Photocopier (high temperature/conductive), printer (high temperature/conductive)
KRYTOX GPL 226	Fluororesin	Fluorinated oil		-	280	2	0 - 250		Photocopier (high temperature), printer (high temperature)
Multemp PSNo.2	Lithium	Mineral oil, ester oil	Pinkish white, viscous	-	275	2	-40 - 100		Motor (for low temperatures)
KVC grease	Urea	PAO ¹⁾ , ester oil	Milkish pink	-	244	3	-30 - 150		Motor (for high temperatures), rotary encoder, fan motor (for high temperatures)
SR grease	Lithium	Ester oil	Light brown, viscous	-	250	3	-40 - 130	Extra-small/miniature ball bearings, automobile	Motor, stepping motor, fan motor Center bearing (for propeller shafts), steering column
KDL grease	Fluororesin (PTFE)	Fluorinated oil	White	-	260	2 - 3 ²⁾	-30 - 200	Semiconductor manufacturing equipment	For high temperatures, for clean environment, for vacuum environment
KHD	Lithium	PAO ¹⁾	White	-	199	4	-30 - 120		For room temperature, for atmosphere
Nerita 2858	Lithium	Mineral oil (XHVI)	Yellowish brown	-	279	2	-30 - 100	Railway rolling stock	Axle journal (ABU)
Arapen RB 320	Lithium, calcium	Mineral oil	Yellowish brown	-	315	1	-30 - 90		Axle journal (general)
Isoflex NBU 15	Barium complex	Ester oil	Beige	270	280	2	-40 - 100	Machine tool spindle	
Shell Cassida grease RLS2	Aluminum complex	PAO ¹⁾	Transparent	-	280	2	-20 - 100	For food machinery	
Alvania EP2	Lithium	Mineral oil	Brown	282	276	2	-10 - 80	Slewing rim, automobile	Universal joint, king pin thrust bearing
Alvania 3	Lithium	Mineral oil	Brown	240	225	3	-10 - 100	Agricultural machinery	

[Notes] 1) PAO: Polyalphaolefin oil

2) The value is within the range specified by the consistency numbers.

12-2-2 Lubricating oil

For lubrication, bearings usually employ highly refined mineral oils, which have superior oxidation stability, rust-preventive effect, and high film strength.

With bearing diversification, however, various synthetic oils have been put into use.

These synthetic oils contain various additives (oxidation inhibitors, rust preventives, antifoaming agents, etc.) to improve specific properties. Table 12-6 shows the characteristics of lubricating oils.

Mineral lubricating oils are classified by applications in JIS and MIL.

Table 12-6 Characteristics of lubricating oils

Type of lubricating oil	Highly refined mineral oil	Major synthetic oils				
		Diester oil	Silicon oil	Polyglycolic oil	Polyphenyl ether oil	Fluorinated oil
Operating temperature range (°C)	- 40 to + 220	- 55 to + 150	- 70 to + 350	- 30 to + 150	0 to + 330	- 20 to + 300
Lubricity	Excellent	Excellent	Fair	Good	Good	Excellent
Oxidation stability	Good	Good	Fair	Fair	Excellent	Excellent
Radioactivity resistance	Bad	Bad	Bad to fair	Bad	Excellent	-

[Selection of lubricating oil]

The most important criterion in selecting a lubricating oil is whether the oil provides proper viscosity at the bearing operating temperature.

Standard values of proper kinematic viscosity can be obtained through selection by bearing type according to Table 12-7 first, then through selection by bearing operating conditions according to Table 12-8.

When lubricating oil viscosity is too low, the oil film will be insufficient. On the other hand, when the viscosity is too high, heat will be generated due to viscous resistance.

In general, the heavier the load and the higher the operating temperature, the higher the lubricating oil viscosity should be ; whereas, the higher the rotation speed, the lower the viscosity should be.

Fig. 12-3 illustrates the relationship between lubricating oil viscosity and temperature.

Table 12-7 Proper kinematic viscosity by bearing type

Bearing type	Proper kinematic viscosity at operating temperature
Ball bearing Cylindrical roller bearing	13mm ² /s or higher
Tapered roller bearing Spherical roller bearing	20mm ² /s or higher
Spherical thrust roller bearing	32mm ² /s or higher

Table 12-8 Proper kinematic viscosities by bearing operating conditions

Operating temperature	d _{m/n} value	Proper kinematic viscosity (expressed in the ISO viscosity grade or the SAE No.)	
		Light/normal load	Heavy/impact load
- 30 to 0°C	All rotation speeds	ISO VG 15, 22, 46 (Refrigerating machine oil)	---
0 to 60°C	300 000 or lower	ISO VG 46 (Bearing oil Turbine oil)	ISO VG 68 SAE 30 (Bearing oil Turbine oil)
	300 000 to 600 000	ISO VG 32 (Bearing oil Turbine oil)	ISO VG 68 (Bearing oil Turbine oil)
	600 000 or higher	ISO VG 7, 10, 22 (Bearing oil)	---
60 to 100°C	300 000 or lower	ISO VG 68 (Bearing oil)	ISO VG 68, 100 SAE 30 (Bearing oil)
	300 000 to 600 000	ISO VG 32, 46 (Bearing oil Turbine oil)	ISO VG 68 (Bearing oil Turbine oil)
	600 000 or higher	ISO VG 22, 32, 46 (Bearing oil Turbine oil Machine oil)	---
100 to 150°C	300 000 or lower	ISO VG 68, 100 SAE 30, 40 (Bearing oil)	ISO VG 100 to 460 (Bearing oil Gear oil)
	300 000 to 600 000	ISO VG 68 SAE 30 (Bearing oil Turbine oil)	ISO VG 68, 100 SAE 30, 40 (Bearing oil)

[Remarks] 1. $d_{m/n} = \frac{D+d}{2} \times n$ { D : nominal outside diameter (mm), d : nominal bore diameter (mm), n : rotational speed (min⁻¹) }

2. Refer to refrigerating machine oil (JIS K 2211), turbine oil (JIS K 2213), gear oil (JIS K 2219), machine oil (JIS K 2238) and bearing oil (JIS K 2239).

3. Please contact with JTEKT if the bearing operating temperature is under -30°C or over 150°C .

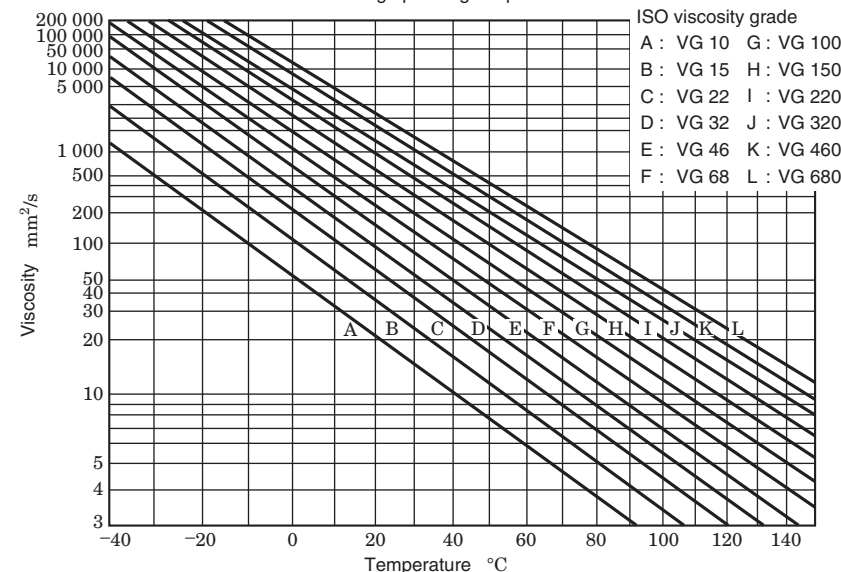

Fig. 12-3 Relationship between lubricating oil viscosity and temperature (viscosity index :100)

13. Bearing materials

Bearing materials include steel for bearing rings and rolling elements, as well as steel sheet, steel, copper alloy and synthetic resins for cages.

These bearing materials should possess the following characteristics :

- | | |
|--|--|
| 1) High elasticity, durable under high partial contact stress. | } Bearing rings |
| 2) High strength against rolling contact fatigue due to large repetitive contact load. | |
| 3) Strong hardness | } Rolling elements |
| 4) High abrasion resistance | |
| 5) High toughness against impact load | } Bearing rings
Rolling elements
Cages |
| 6) Excellent dimensional stability | |

13-1 Bearing rings and rolling elements materials

1) High carbon chromium bearing steel

High carbon chromium bearing steel specified in JIS is used as a general material in bearing rings (inner rings, outer rings) and rolling elements (balls, rollers).

Their chemical composition classified by steel type is given in Table 13-1.

Among these steel types, SUJ 2 is generally used. SUJ 3, which contains additional Mn and Si, possesses high hardenability and is commonly used for thick section bearings.

SUJ 5 has increased hardenability, because it was developed by adding Mo to SUJ 3.

For small and medium size bearings, SUJ 2 and SUJ 3 are used, and for large size and extra-large size bearings with thick sections, SUJ 5 is widely used.

Generally, these materials are processed into the specified shape and then undergo hardening and annealing treatment until they attain a hardness of 57 to 64 HRC.

Table 13-1 Chemical composition of high carbon chromium bearing steel

Standard	Code	Chemical composition (%)						
		C	Si	Mn	P	S	Cr	Mo
JIS G 4805	SUJ 2	0.95 - 1.10	0.15 - 0.35	Not more than 0.50	Not more than 0.025	Not more than 0.025	1.30 - 1.60	Not more than 0.08
	SUJ 3	0.95 - 1.10	0.40 - 0.70	0.90 - 1.15			0.90 - 1.20	Not more than 0.08
	SUJ 5	0.95 - 1.10	0.40 - 0.70	0.90 - 1.15			0.90 - 1.20	0.10 - 0.25
SAE J 404	52100	0.98 - 1.10	0.15 - 0.35	0.25 - 0.45	Not more than 0.025	Not more than 0.025	1.30 - 1.60	Not more than 0.06

[Remark] As for bearings which are induction hardened, carbon steel with a high carbon content of 0.55 to 0.65 % is used in addition to those listed in this table.

2) Case carburizing bearing steel (case hardened steel)

When a bearing receives heavy impact loads, the surface of the bearing should be hard and the inside soft.

Such materials should possess a proper amount of carbon, dense structure, and carburizing case depth on their surface, while having proper hardness and fine structure internally.

For this purpose, chromium steel and nickel-chromium-molybdenum steel are used as materials.

Typical steel materials are shown in Table 13-2.

3) Steel for Standard JTEKT Specification Bearings

In general terms, it is known that the non-metallic inclusions contained in materials are harmful to the rolling contact fatigue life.

At JTEKT, to reduce the amount of non-metallic inclusions, which are harmful to the fatigue life, we set the chemical compounds of the bearing steel in a proprietary manner. As a result, JTEKT standard bearings have a life that is approximately twice as long as the general bearings that are targeted by JIS B 1518 (and ISO 281).

Therefore, the basic dynamic load ratings of JTEKT standard bearings are 1.25 times the dynamic load ratings established in JIS B 1518 (and ISO 281).

This steel for standard JTEKT specification bearings is not applied to the special application bearings in this general catalog. If you require special application bearings with long lives, contact JTEKT.

4) Other

For special applications, the special heat treatment shown below can be used according to various usage conditions.

[Extremely high reliability]

· SH bearings ¹⁾

..... By using the heat treatment technology developed by JTEKT to perform special heat treatment on high carbon chromium bearing steel, we have improved the surface hardness of these products and provided them with compressive residual stress, which has led to high reliability especially in terms of resistance to foreign matter.

· KE bearings ²⁾

..... By using the heat treatment technology developed by JTEKT to perform special heat treatment on carburized bearing steel, we have improved the surface hardness of these products and adjusted their amount of residual austenite, which has led to high reliability especially in terms of resistance to foreign matter.

1) Acronym of Special Heat treatment

2) Acronym of Koyo EXTRA-LIFE Bearing

Table 13-2 Chemical composition of case carburizing bearing steel

Standard	Code	Chemical composition (%)							
		C	Si	Mn	P	S	Ni	Cr	Mo
JIS G 4053	SCr 415	0.13 - 0.18	0.15 - 0.35	0.60 - 0.85	Not more than 0.030	Not more than 0.030	-	0.90 - 1.20	-
	SCr 420	0.18 - 0.23	0.15 - 0.35	0.60 - 0.85			-	0.90 - 1.20	-
	SCM 420	0.18 - 0.23	0.15 - 0.35	0.60 - 0.85	Not more than 0.030	Not more than 0.030	-	0.90 - 1.20	0.15 - 0.30
	SNCM 220	0.17 - 0.23	0.15 - 0.35	0.60 - 0.90			0.40 - 0.70	0.40 - 0.65	0.15 - 0.30
	SNCM 420	0.17 - 0.23	0.15 - 0.35	0.40 - 0.70	Not more than 0.030	Not more than 0.030	1.60 - 2.00	0.40 - 0.65	0.15 - 0.30
	SNCM 815	0.12 - 0.18	0.15 - 0.35	0.30 - 0.60			4.00 - 4.50	0.70 - 1.00	0.15 - 0.30
SAE J 404	5120	0.17 - 0.22	0.15 - 0.35	0.70 - 0.90	Not more than 0.035	Not more than 0.040	-	0.70 - 0.90	-
	8620	0.18 - 0.23	0.15 - 0.35	0.70 - 0.90			0.40 - 0.70	0.40 - 0.60	0.15 - 0.25
	4320	0.17 - 0.22	0.15 - 0.30	0.45 - 0.65	Not more than 0.025	Not more than 0.025	1.65 - 2.00	0.40 - 0.60	0.20 - 0.30

13-2 Materials used for cages

Since the characteristics of materials used for cages greatly influence the performance and reliability of rolling bearings, the choice of materials is of great importance.

It is necessary to select cage materials in accordance with required shape, ease of lubrication, strength, and abrasion resistance.

Typical materials used for metallic cages are shown in Tables 13-3 and 13-4.

In addition, phenolic resin machined cages and other synthetic resin molded cages are often used.

Materials typically used for molded cages are polyacetal, polyamide (Nylon 6.6, Nylon 4.6), and polymer containing fluorine, which are strengthened with glass and carbon fibers.

Table 13-3 Chemical compositions of pressed cage steel sheet (A) and machined cage carbon steel (B)

	Standard	Code	Chemical composition (%)						
			C	Si	Mn	P	S	Ni	Cr
(A)	JIS G 3141	SPCC	Not more than 0.12	–	Not more than 0.50	Not more than 0.040	Not more than 0.045	–	–
	JIS G 3131	SPHC	Not more than 0.15	–	Not more than 0.60	Not more than 0.050	Not more than 0.050	–	–
	BAS 361	SPB 2	0.13 – 0.20	Not more than 0.04	0.25 – 0.60	Not more than 0.030	Not more than 0.030	–	–
	JIS G 4305	SUS 304	Not more than 0.08	Not more than 1.00	Not more than 2.00	Not more than 0.045	Not more than 0.030	8.00 – 10.50	18.00 – 20.00
(B)	JIS G 4051	S 25 C	0.22 – 0.28	0.15 – 0.35	0.30 – 0.60	Not more than 0.030	Not more than 0.035	–	–

Table 13-4 Chemical composition of high-tensile brass casting of machined cages (%)

Standard	Code	Cu	Zn	Mn	Fe	Al	Sn	Ni	Impurity	
									Pb	Si
JIS H 5120	CAC 301 (HBsC*)	55 – 60	33 – 42	0.1 – 1.5	0.5 – 1.5	0.5 – 1.5	Not more than 1.0	Not more than 1.0	Not more than 0.4	Not more than 0.1

* : Material with HBsC is used.

14. Shaft and housing design

In designing the shaft and housing, the following should be taken into consideration.

- 1) Shafts should be thick and short. (in order to reduce distortion including bending)
- 2) Housings should possess sufficient rigidity. (in order to reduce distortion caused by load)
[Note] · For light alloy housings, rigidity may be provided by inserting a steel bushing.

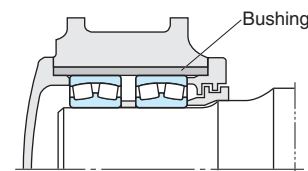

Fig. 14-1 Example of light alloy housing

- 3) The fitting surface of the shaft and housing should be finished in order to acquire the required accuracy and roughness. The shoulder end-face should be finished in order to be perpendicular to the shaft center or housing bore surface. (refer to Table 14-1)
- 4) The fillet radius (r_a) should be smaller than chamfer dimension of the bearing. (refer to Tables 14-2, 14-3)
[Notes] · Generally it should be finished so as to form a simple circular arc. (refer to Fig. 14-2)
· When the shaft is given a ground finish, a recess may be provided. (Fig. 14-3)

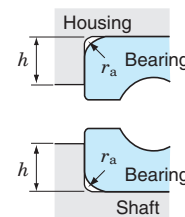

Fig. 14-2 Fillet radius

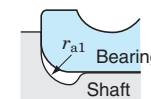

Fig. 14-3 Grinding undercut

- 5) The shoulder height (h) should be smaller than the outside diameter of inner ring and larger than bore diameter of outer ring so that the bearing is easily dismounted. (refer to Fig. 14-2 and Table 14-2)
- 6) If the fillet radius must be larger than the bearing chamfer, or if the shaft/housing shoulder must be low/high, insert a spacer between the inner ring and shaft shoulder as shown in Fig. 14-4, or between the outer ring and the housing shoulder.

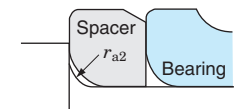

Fig. 14-4 Example of shaft with spacer

- 7) Screw threads and lock nuts should be completely perpendicular to shaft axis. It is desirable that the tightening direction of threads and lock nuts be opposite to the shaft rotating direction.
- 8) When split housings are used, the surfaces where the housings meet should be finished smoothly and provided with a recess at the inner ends of the surfaces that meet.

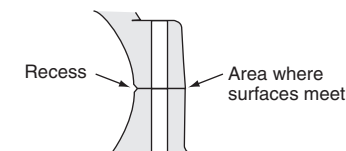

Fig. 14-5 Recesses on meeting surfaces

14-1 Accuracy and roughness of shafts and housings

The fitting surface of the shaft and housing may be finished by turning or fine boring when the bearing is used under general operating conditions. However, if the conditions require minimum vibration and noise, or if the bearing is used under severe operating conditions, a ground finish is required.

Recommended accuracy and roughness of shafts and housings under general conditions are given in Table 14-1.

Table 14-1 Recommended accuracy and roughness of shafts and housings

Item	Bearing class	Shaft	Housing bore
Roundness tolerance	classes 0, 6	IT 3 – IT 4	IT 4 – IT 5
	classes 5, 4	IT 2 – IT 3	IT 2 – IT 3
Cylindrical form tolerance	classes 0, 6	IT 3 – IT 4	IT 4 – IT 5
	classes 5, 4	IT 2 – IT 3	IT 2 – IT 3
Shoulder runout tolerance	classes 0, 6	IT 3	IT 3 – IT 4
	classes 5, 4	IT 3	IT 3
Roughness of fitting surfaces Ra	Small size bearings	0.8 a	1.6 a
	Large size bearings	1.6 a	3.2 a

[Remark] Refer to the figures listed in the attached table when the basic tolerance IT is required.

Table 14-2 Shaft/housing fillet radius and shoulder height of radial bearings

Unit : mm

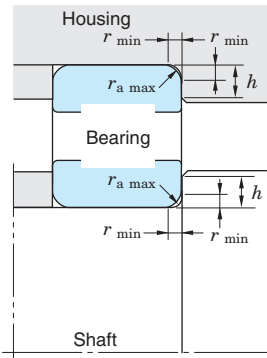

Chamfer dimension of inner ring or outer ring	Shaft and housing		
	Fillet radius	Shoulder height	
		General cases ¹⁾	Special cases ²⁾
r_{min}	$r_{a\ max}$	h_{min}	
0.05	0.05	0.3	0.3
0.08	0.08	0.3	0.3
0.1	0.1	0.4	0.4
0.15	0.15	0.6	0.6
0.2	0.2	0.8	0.8
0.3	0.3	1.25	1
0.5	0.5	1.75	1.5
0.6	0.6	2.25	2
0.8	0.8	2.75	2.5
1	1	2.75	2.5
1.1	1	3.5	3.25
1.5	1.5	4.25	4
2	2	5	4.5
2.1	2	6	5.5
2.5	2	6	5.5
3	2.5	7	6.5
4	3	9	8
5	4	11	10
6	5	14	12
7.5	6	18	16
9.5	8	22	20
12	10	27	24
15	12	32	29
19	15	42	38

[Notes]

- Shoulder heights greater than those specified in the Table are required to accommodate heavy axial loads.
- Used when an axial load is small. These values are not recommended for tapered roller bearings, angular contact ball bearings, or spherical roller bearings.

[Remark]

Fillet radius can be applied to thrust bearings.

14-2 Mounting dimensions

Mounting dimensions mean the necessary dimensions to mount bearings on shafts or housings, which include the fillet radius or shoulder diameters.

Standard values are shown in Table 14-2. (The mounting related dimensions of each bearing are given in the bearing specification table.)

The grinding undercut dimensions for ground shafts are given in Table 14-3.

For thrust bearings, the mounting dimensions should be carefully determined such that bearing race will be perpendicular to the support and the supporting area will be wide enough.

For thrust ball bearings, the shaft shoulder diameter d_a should be larger than pitch diameter of ball set, while the shoulder diameter of housing D_a should be smaller than the pitch diameter of ball set. (Fig. 14-6)

For thrust roller bearings, the housing/shaft diameter D_a/d_a should cover the lengths of both rollers. (Fig. 14-7)

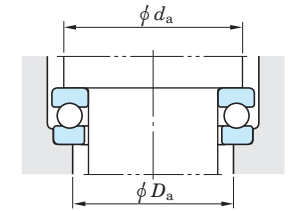
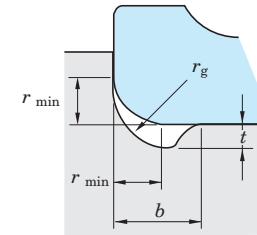

Fig. 14-6 Thrust ball bearings

Table 14-3 Grinding undercut dimensions for ground shafts



Unit : mm

Chamfer dimension of inner ring	Grinding undercut dimensions		
	t	r_g	b
1	0.2	1.3	2
1.1	0.3	1.5	2.4
1.5	0.4	2	3.2
2	0.5	2.5	4
2.1	0.5	2.5	4
3	0.5	3	4.7
4	0.5	4	5.9
5	0.6	5	7.4
6	0.6	6	8.6
7.5	0.6	7	10

Fig. 14-7 Spherical thrust roller bearings

14-3 Shaft design

When bearings are mounted on shafts, locating method should be carefully determined. Shaft design examples for cylindrical bore bearings are given in Table 14-4, and those for bearings with a tapered bore in Table 14-5.

Table 14-4 Mounting designs for cylindrical bore bearings

(a) Shaft locknut	(b) End plate	(c) Locating snap ring
		
<p>Lockwashers are used to prevent loosening of locknuts. When tapered roller bearings or angular contact ball bearings are transition-fitted to shafts, plain washers several mm thick as shown above (at right) should be added and tightened with nut.</p>	<p>End of shaft should have bolt holes.</p>	<p>Used when the housing inside is limited, or to simplify shaft machining.</p>

Table 14-5 Mounting designs for bearings with tapered bore

(d) Adapter assembly	(e) Withdrawal sleeve	(f) Shaft locknut	(g) Split ring
			
<p>The simplest method for axial positioning is just to attach an adapter sleeve to the shaft and tighten the locknuts. To prevent locknut loosening, lock-washer (not more than 180 mm in shaft diameter) or lock plate (not less than 200 mm in shaft diameter) are used.</p>	<p>The locknut (above) or end plate (below) fixes the bearing with a withdrawal sleeve, which makes it easy to dismount the bearing.</p>	<p>The shaft is threaded in the same way as shown in Fig. (a). The bearing is located by tightening locknut.</p>	<p>A split ring with threaded outside diameter is inserted into groove on the tapered shaft. A key is often used to prevent the locknut and split ring from loosening.</p>

14-4 Sealing devices

Sealing devices not only prevent foreign matter (dirt, water, metal powder) from entering, but prevent lubricant inside from leaking. If the sealing device fails to function satisfactorily, foreign matter or leakage will cause bearing damage as a result of malfunction or seizure.

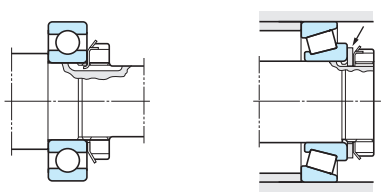
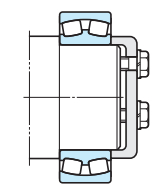
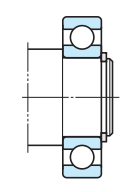
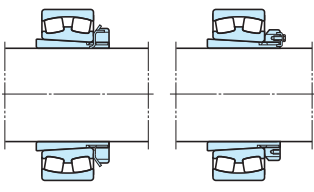
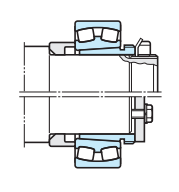
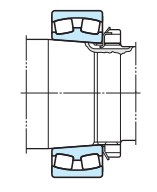
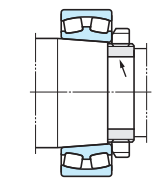
Therefore, it is necessary to design or choose the most suitable sealing devices as well as to choose the proper lubricating measures according to operating conditions.

Sealing devices may be divided into non-contact and contact types according to their structure.

They should satisfy the following conditions :

- Free from excessive friction (heat generation)
- Easy maintenance (especially ease of mounting and dismounting)
- As low cost as possible

14-4-1 Non-contact type sealing devices

A non-contact type sealing device, which includes oil groove, flinger (slinger), and labyrinth, eliminates friction because it does not have a contact point with the shaft.

These devices utilize narrow clearance and centrifugal force and are especially suitable for operation at high rotation speed and high temperature.

Table 14-6 (1) Non-contact type sealing devices

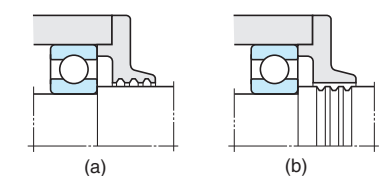
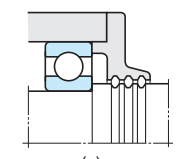
(1) Oil groove



■ This kind of seal having more than three grooves at the narrow clearance between the shaft and housing cover, is usually accompanied by other sealing devices except when it is used with grease lubrication at low rotation speed.

■ Preventing entrance of contaminants can be improved by filling the groove with calcium grease (cup grease) having a consistency of 150 to 200.

■ The clearance between the shaft and housing cover should be as narrow as possible. Recommended clearances are as follows.

- Shaft diameter of less than 50mm 0.25 – 0.4mm
- Shaft diameter of over 50mm 0.5 – 1 mm

■ Recommended dimensions for the oil groove are as follows.

- Width 2 – 5mm
- Depth 4 – 5mm

Table 14-6 (2) Non-contact type sealing devices

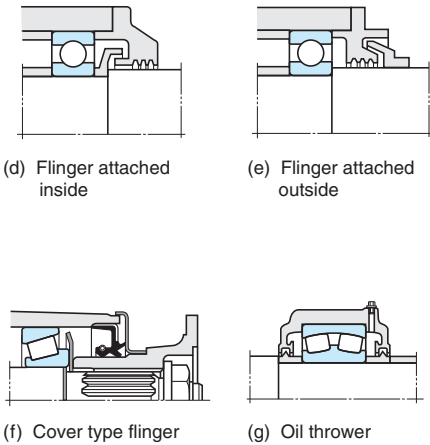
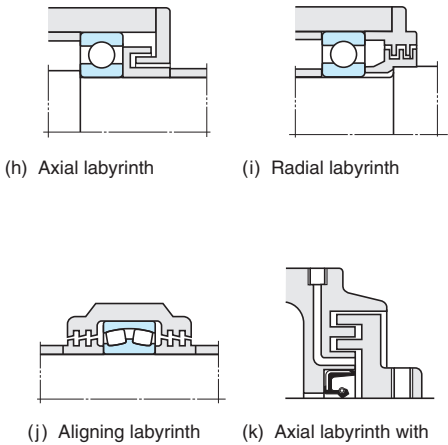
(2) Flinger (slinger)	(3) Labyrinth									
 <p>(d) Flinger attached inside (e) Flinger attached outside</p> <p>(f) Cover type flinger (g) Oil thrower</p>	 <p>(h) Axial labyrinth (i) Radial labyrinth</p> <p>(j) Aligning labyrinth (k) Axial labyrinth with greasing feature</p>									
<ul style="list-style-type: none"> ■ A flinger utilizes centrifugal force to splash away the oil and dirt. It produces an air stream which prevents oil leakage and dirt by a pumping action. In many cases, this device is used together with other sealing devices. ■ A flinger installed inside the housing (Fig. d) provides an inward pumping action, preventing lubricant leakage; and, when installed outside (Fig. e), the outward pumping action prevents lubricant contamination. ■ A cover type flinger (Fig. f) splashes away dirt and dust by centrifugal force. ■ The oil thrower, shown in (Fig. g), is a kind of flinger. An annular ridge on the shaft or a ring fitted onto the shaft utilizes centrifugal force to prevent the lubricant from flowing out. 	<ul style="list-style-type: none"> ■ A labyrinth provides clearance in the shape of engagements between the shaft and housing. It is the most suitable for prevention of lubricant leakage at high rotation speed. ■ Though an axial labyrinth, shown in (Fig. h), is popular because of its ease of mounting, the sealing effect is better in a radial labyrinth, shown in (Fig. i). ■ An aligning labyrinth (Fig. j) is used with self-aligning type bearings. ■ In the cases of (Fig. i) and (Fig. j), the housing or the housing cover should be split. ■ Recommended labyrinth clearances are given in the following table. <table border="1" style="width: 100%; border-collapse: collapse;"> <thead> <tr> <th style="background-color: #e0f0ff;">Shaft diameter</th> <th style="background-color: #e0f0ff;">Radial clearance</th> <th style="background-color: #e0f0ff;">Axial clearance</th> </tr> </thead> <tbody> <tr> <td>50mm or less</td> <td>0.25 - 0.4mm</td> <td>1 - 2mm</td> </tr> <tr> <td>Over 50mm</td> <td>0.5 - 1 mm</td> <td>3 - 5mm</td> </tr> </tbody> </table> <ul style="list-style-type: none"> ■ To improve sealing effect, fill the labyrinth clearance with grease, shown in (Fig. k). 	Shaft diameter	Radial clearance	Axial clearance	50mm or less	0.25 - 0.4mm	1 - 2mm	Over 50mm	0.5 - 1 mm	3 - 5mm
Shaft diameter	Radial clearance	Axial clearance								
50mm or less	0.25 - 0.4mm	1 - 2mm								
Over 50mm	0.5 - 1 mm	3 - 5mm								

14-4-2 Contact type sealing devices

This type provides a sealing effect by means of the contact of its end with the shaft and are manufactured from synthetic rubber, synthetic resin, or felt.
The synthetic rubber oil seal is most popular.

1) Oil seals

Many types and sizes of oil seals, as a finished part, have been standardized. JTEKT produces various oil seals. The names and functions of each oil seal part are shown in Fig. 14-8 and Table 14-7. Table 14-8 provides a representative example.

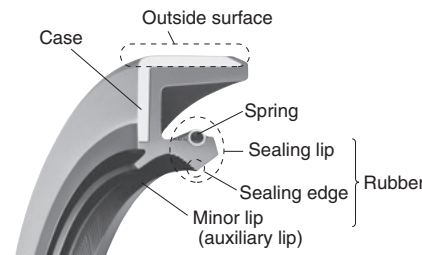

Fig. 14-8 Names of oil seal parts

Table 14-7 Complete list of oil seal part functions

Names	Functions
Sealing edge	Prevents fluid leakage by making contact with rotating shaft. <div style="border: 1px solid black; padding: 2px;">The contact surface of the sealing edge with the shaft should always be filled with lubricant, so as to maintain an oil film therein.</div>
Sealing lip and spring	Provides proper pressure on the sealing edge to maintain stable contact. Spring provides proper pressure on the lip and maintains such pressure for a long time.
Outside surface	Fixes the oil seal to the housing and prevents fluid leakage through the fitting surface. <div style="border: 1px solid black; padding: 2px;">Comes encased in metal cased type or rubber covered type.</div>
Case	Strengthens seal.
Minor lip (auxiliary lip)	Prevents entry of contaminants. <div style="border: 1px solid black; padding: 2px;">In many cases, the space between the sealing lip and minor lip is filled with grease.</div>

Table 14-8 Typical oil seal types

With case		With inner case		Without case	
Without spring	With spring			With spring	
 HM (JIS GM) MH (JIS G)	 HMS (JIS SM) MHS (JIS S) CRS	 HMSH (JIS SA)	 MS		
 HMA MHA	 HMSA (JIS DM) MHA (JIS D) CRSA	 HMSAH (JIS DA)			
<ul style="list-style-type: none"> • The oil seals shown in the lower row contain the minor lip (auxiliary lip). • Special types of seals such as the mud resistance seal, pressure resistance seal and outer seal for rotating housings can be provided to serve under various operating conditions. 				<ul style="list-style-type: none"> • By providing a slit on the oil seals, it is possible to attach them from other points than the shaft ends. 	

Oil seals without minor lips are mounted in different directions according to their operating conditions (shown in Fig. 14-9).

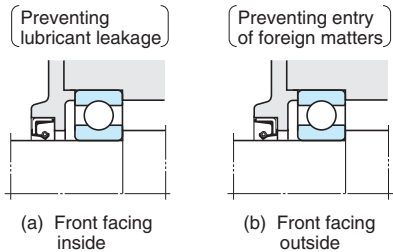

Fig. 14-9 Direction of sealing lips and their purpose

When the seal is used in a dirty operating environment, or penetration of water is expected, it is advisable to have two oil seals combined or to have the space between the two sealing lips be filled with grease.

(shown in Fig. 14-10)

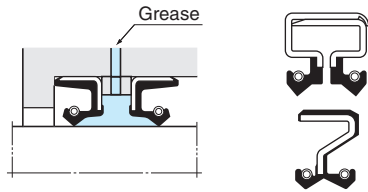

Fig. 14-10 Seals used in a dirty operating environment

Respective seal materials possess different properties. Accordingly, as shown in Table 14-9, allowable lip speed and operating temperature differ depending on the materials. Therefore, by selecting proper materials, oil seals can be used for sealing not only lubricants but also chemicals including alcohol, acids, alkali, etc.

Table 14-9 Allowable lip speed and operating temperature range of oil seals

Seal material	Allowable lip speed (m/s)	Operating temperature range (°C)
NBR	15	- 40 to + 120
Acrylic rubber	25	- 30 to + 150
Silicone rubber	32	- 50 to + 170
Fuoro rubber	32	- 20 to + 180

To ensure the maximum sealing effect of the oil seal, the shaft materials, surface roughness and hardness should be carefully chosen.

Table 14-10 shows the recommended shaft conditions.

Table 14-10 Recommended shaft conditions

Material	Machine structure steel, low alloy steel and stainless steel
Surface hardness	For low speed : harder than 30 HRC For high speed : harder than 50 HRC
Surface roughness (Ra)	0.2 - 0.6a A surface which is excessively rough may cause oil leakage or abrasion ; whereas an excessively fine surface may cause sealing lip seizure, preventing the oil film from forming. Surface must also be free of spiral grinding marks.

2) Felt seals and others

Although felt seals have been used conventionally, it is recommended to replace them with rubber oil seals because the use of felt seals are limited to the following conditions.

- Light dust protection
- Allowable lip speed : not higher than 5m/s

Contact type sealing devices include mechanical seals, O-rings and packings other than those described herein.

JTEKT manufactures various oil seals ranging from those illustrated in Table 14-8 to special seals for automobiles, large seals for rolling mills, mud resistance seals, pressure resistance seals, outer seals for rotating housings and O-rings.
For details, refer to JTEKT separate catalog "Oil seals & O-rings" (CAT. NO. R2001E).

15. Handling of bearings

15-1 General instructions

Since rolling bearings are more precisely made than other machine parts, careful handling is absolutely necessary.

- 1) Keep bearings and the operating environment clean.
- 2) Handle carefully.
Bearings can be cracked and brinelled easily by strong impact if handled roughly.
- 3) Handle using the proper tools.
- 4) Keep bearings well protected from rust. Do not handle bearings in high humidity. Operators should wear gloves in order not to soil bearings with perspiration from their hands.
- 5) Bearings should be handled by experienced or well trained operators.
 - Storage of bearings
 - Cleaning of bearings and their adjoining parts.
 - Inspection of dimensions of adjoining parts and finish conditions
 - Mounting
 - Inspection after mounting
 - Dismounting
 - Maintenance and inspection (periodical inspection)
 - Replenishment of lubricants
- 6) Set bearing operation standards and follow them.

Since the anti-corrosion oil covering bearings is a highly capable lubricant, the oil should not be cleaned off if the bearings are pre-lubricated, or when the bearings are used for normal operation. However, if the bearings are used in measuring instruments or at high rotation speed, the anti-corrosion oil should be removed using a clean detergent oil. After removal of the anti-corrosion oil, bearings should not be left for a long time because they rust easily.

2) Inspection of shafts and housings

Clean up the shaft and housing to check whether it has flaws or burrs as a result of machining.

Be very careful to completely remove lapping agents (SiC, Al₂O₃, etc.), casting sands, and chips from inside the housing.

Next, check that the dimensions, forms, and finish conditions of the shaft and the housing are accurate to those specified on the drawing.

The shaft diameter and housing bore diameter should be measured at the several points as shown in Figs. 15-1 and 15-2.

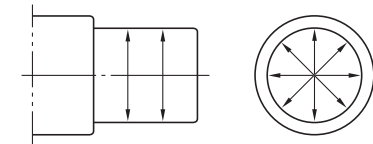

Fig. 15-1 Measuring points on shaft diameter

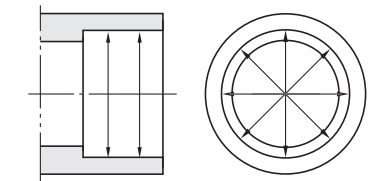

Fig. 15-2 Measuring points on housing bore diameter

15-2 Storage of bearings

In shipping bearings, since they are covered with proper anti-corrosion oil and are wrapped in antitarnish paper, the quality of the bearings is guaranteed as long as the wrapping paper is not damaged.

If bearings are to be stored for a long time, it is advisable that the bearings be stored on shelves set higher than 30 cm from the floor, at a humidity less than 65 %, and at a temperature around 20°C.

Avoid storage in places exposed directly to the sun's rays or placing boxes of bearings against cold walls.

15-3 Bearing mounting

15-3-1 Recommended preparation prior to mounting

1) Preparation of bearings

Wait until just before mounting before removing the bearings from their packaging to prevent contamination and rust.

Furthermore, fillet radius of shaft and housing, and the squareness of shoulders should be checked.

When using shaft and housing which have passed inspection, it is advisable to apply machine oil to each fitting surface just before mounting.

15-3-2 Bearing mounting

Mounting procedures depend on the type and fitting conditions of bearings.

For general bearings in which the shaft rotates, an interference fit is applied to inner rings, while a clearance fit is applied to outer rings.

For bearings in which the outer rings rotate, an interference fit is applied to the outer rings.

Interference fitting is roughly classified as shown here. The detailed mounting processes are described in Tables 15-1 to 15-3.

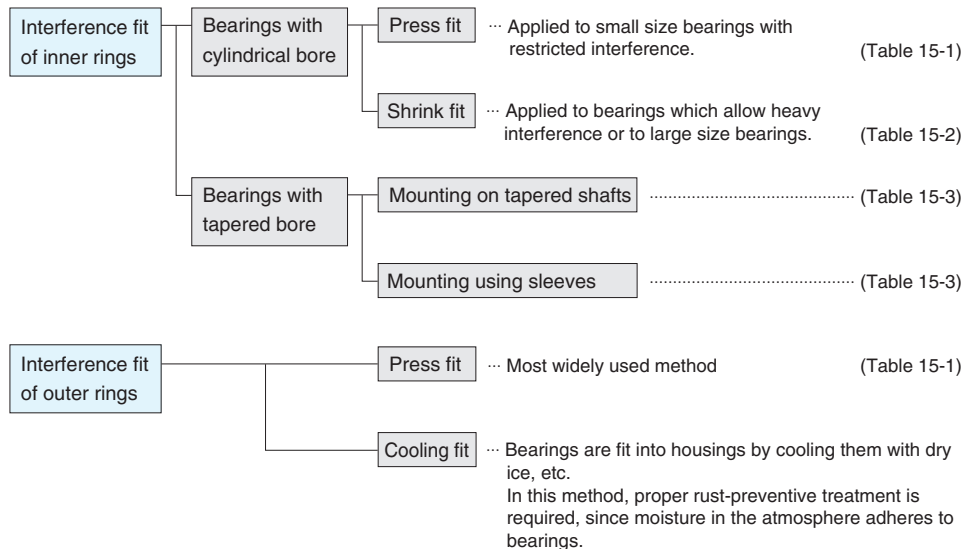

Table 15-1 Press fit of bearings with cylindrical bores

Mounting methods	Descriptions
<p>(a) Using press fit (the most widely used method)</p>	<p>As shown in the Fig., a bearing should be mounted slowly with care, by using a fixture to apply force evenly to the bearing. When mounting the inner ring, apply pressure to the inner ring only. Similarly, in mounting the outer ring, press only the outer ring.</p> <p>(Inner ring press fit) (Outer ring press fit) (Inner ring press fit)</p> <p>If interference is required on both the inner and outer ring of non-separable bearings, use two kinds of fixtures as shown in the Fig. and apply force carefully, as rolling elements are easily damaged. Be sure never to use a hammer in such cases.</p> <p>Simultaneous press fit of inner ring and outer ring</p>
<p>(b) Using bolts and nuts</p> <p>screw hole should be provided at the shaft end</p>	
<p>(c) Using hammers</p> <p>only when there is no alternative measure</p>	

Reference Force is necessary to press fit or remove bearings.

The force necessary to press fit or remove inner rings of bearings differs depending on the finish of shafts and how much interference the bearings allow.

The standard values can be obtained by using the following equations.

(Solid shafts) $K_a = 9.8 f_k \cdot \Delta_{def} \cdot B \left(1 - \frac{d^2}{D_i^2} \right) \times 10^3$ (15-1)

(Hollow shafts) $K_a = 9.8 f_k \cdot \Delta_{def} \cdot B \frac{\left(1 - \frac{d^2}{D_i^2} \right) \left(1 - \frac{d_0^2}{d^2} \right)}{\left(1 - \frac{d_0^2}{D_i^2} \right)} \times 10^3$ (15-2)



In equations (15-1) and (15-2),

- K_a : force necessary for press fit or removal N
- Δ_{def} : effective interference mm
- f_k : resistance coefficient
- [Coefficient taking into consideration friction between shafts and inner rings] ... refer to the table on the right
- B : nominal inner ring width mm
- d : nominal inner ring bore diameter mm
- D_i : average outside diameter of inner ring mm
- d_0 : hollow shaft bore diameter mm

Value of resistance coefficient f_k

Conditions	f_k
Press fitting bearings on to cylindrical shafts	4
Removing bearings from cylindrical shafts	6
Press fitting bearings on to tapered shafts or tapered sleeves	5.5
Removing bearings from tapered shafts or tapered sleeves	4.5
Press fitting tapered sleeves between shafts and bearings	10
Removing tapered sleeves from the space between shafts and bearings	11

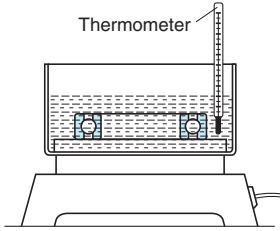
Table 15-2 Shrink fit of cylindrical bore bearings

Shrink fit	Descriptions
 <p>(a) Heating in an oil bath</p>	<p>■ This method, which expands bearings by heating them in oil, has the advantage of not applying too much force to bearings and taking only a short time.</p> <p>[Notes]</p> <ul style="list-style-type: none"> ● Oil temperature should not be higher than 100 °C, because bearings heated at higher than 120 °C lose hardness. ● Heating temperature can be determined from the bore diameter of a bearing and the interference by referring to Fig. 15-3. ● Use nets or a lifting device to prevent the bearing from resting directly on the bottom of the oil container. ● Since bearings shrink in the radial direction as well as the axial direction while cooling down, fix the inner ring and shaft shoulder tightly with the shaft nut before shrinking, so that no space is left between them. <p>■ Shrink fit proves to be clean and effective since, by this method, the ring can be provided with even heat in a short time using neither fire nor oil.</p> <p>(When electricity is being conducted, the bearing itself generates heat by its electrical resistance, aided by the built-in exciting coil.)</p>
 <p>(b) Induction heater</p>	

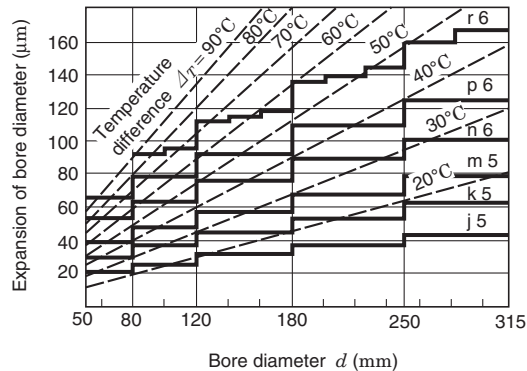

Fig. 15-3 Heating temperature and expansion of inner rings

[Remarks]

1. Thick solid lines show the maximum interference value between bearings (class 0) and shafts (r 6, p 6, n 6, m 5, k 5, j 5) at normal temperature.
 2. Therefore, the heating temperature should be selected to gain a larger "expansion of the bore diameter" than the maximum interference values.
- (When fitting class 0 bearings having a 90 mm bore diameter to m 5 shafts, this figure shows that heating temperature should be 40 °C higher than room temperature to produce expansion larger than the maximum interference value of 48 µm. However, taking cooling during mounting into consideration, the temperature should be set 20 to 30 °C higher than the temperature initially required.)

Table 15-3 Mounting bearings with tapered bores

Mounting methods	Descriptions
 <p>① Locknut ② Hydraulic nut</p> <p>(a) Mounting on tapered shafts</p>	<p>■ When mounting bearings directly on tapered shafts, provide oil holes and grooves on the shaft and inject high pressure oil into the space between the fitting surfaces (oil injection). Such oil injection can reduce tightening torque of locknut by lessening friction between the fitting surfaces.</p> <p>■ When exact positioning is required in mounting a bearing on a shaft with no shoulder, use a clamp to help determine the position of the bearing.</p>  <p>Locating bearing by use of a clamp</p> <p>■ When mounting bearings on shafts, locknuts are generally used. Special spanners are used to tighten them. Bearings can also be mounted using hydraulic nuts.</p>  <p>special spanner</p> <p>■ When mounting tapered bore spherical roller bearings, the reduction in the radial internal clearance which gradually occurs during operation should be taken into consideration as well as the push-in depth described in Table 15-4.</p> <p>Clearance reduction can be measured by a thickness gage. First, stabilize the roller in the proper position and then insert the gage into the space between the rollers and the outer ring. Be careful that the clearance between both roller rows and the outer rings is roughly the same ($e \approx e'$). Since the clearance may differ at different measuring points, take measurements at several positions.</p> <p>■ When mounting self-aligning ball bearings, leave enough clearance to allow easy aligning of the outer ring.</p>
 <p>① Locknut ② Hydraulic nut</p> <p>(b) Mounting by use of an adapter sleeve</p>	
 <p>① Locknut ② Hydraulic nut</p> <p>(c) Mounting by use of a withdrawal sleeve</p>	
 <p>(d) Measuring clearances</p>	

Table 15-4 Mounting tapered bore spherical roller bearings

Nominal bore diameter d mm		Reduction of radial internal clearance μm		Axial displacement, mm				Minimum required residual clearance, μm		
				1/12 taper		1/30 taper		C N clearance	C 3 clearance	C 4 clearance
over	up to	min.	max.	min.	max.	min.	max.			
24	30	15	20	0.27	0.35	-	-	10	20	35
30	40	20	25	0.32	0.4	-	-	15	25	40
40	50	25	35	0.4	0.5	-	-	20	30	45
50	65	30	40	0.45	0.6	-	-	25	35	55
65	80	35	50	0.55	0.75	-	-	35	40	70
80	100	40	55	0.65	0.85	-	-	40	50	85
100	120	55	70	0.85	1.05	2.15	2.65	45	65	100
120	140	65	90	1.0	1.2	2.5	3.0	55	80	110
140	160	75	100	1.1	1.35	2.75	3.4	55	90	130
160	180	80	110	1.2	1.5	3.0	3.8	60	100	150
180	200	90	120	1.4	1.7	3.5	4.3	70	110	170
200	225	100	130	1.55	1.85	3.85	4.6	80	120	190
225	250	110	140	1.7	2.05	4.25	5.1	90	130	210
250	280	120	160	1.8	2.3	4.5	5.75	100	140	230
280	315	130	180	2.0	2.5	5.0	6.25	110	150	250
315	355	150	200	2.3	2.8	5.75	7.0	120	170	270
355	400	170	220	2.5	3.1	6.25	7.75	130	190	300
400	450	190	240	2.8	3.4	7.0	8.5	140	210	330
450	500	210	270	3.1	3.8	7.75	9.5	160	230	360
500	560	240	310	3.5	4.3	8.75	10.8	170	260	370
560	630	260	350	3.9	4.8	9.75	12.0	200	300	410
630	710	300	390	4.3	5.3	10.8	13.3	210	320	460
710	800	340	430	4.8	6.0	12.0	15.0	230	370	530
800	900	370	500	5.3	6.7	13.3	16.8	270	410	570
900	1000	410	550	5.9	7.4	14.8	18.5	300	450	640

[Remark] The values for reduction of radial internal clearance listed above are values obtained when mounting bearings with CN clearance on solid shafts. In mounting bearings with C 3 clearance, the maximum value listed above should be taken as the standard.

15-4 Test run

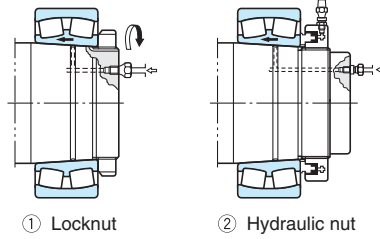
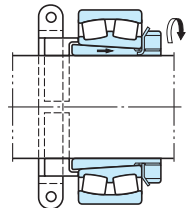
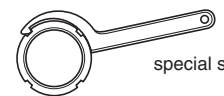
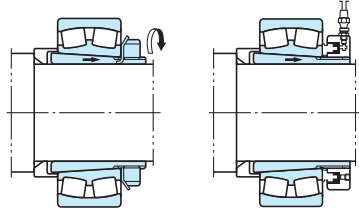
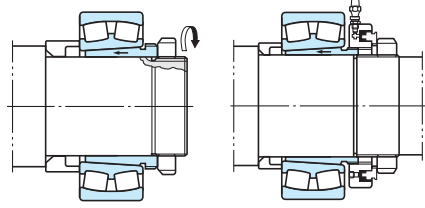
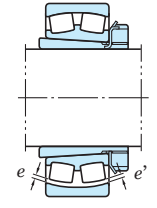
A trial operation is conducted to insure that the bearings are properly mounted.

In the case of compact machines, rotation may be checked by manual operation at first.

If no abnormalities, such as those described below, are observed, then further trial operation proceeds using a power source.

- Knocking ... due to flaws or insertion of foreign matter on rolling contact surfaces.
- Excessive torque (heavy) ... due to friction on sealing devices, too small clearances, and mounting errors.

- Uneven running torque ... due to improper mounting and mounting errors.

For machines too large to allow manual operation, idle running is performed by turning off the power source immediately after turning it on. Before starting power operation, it must be confirmed that bearings rotate smoothly without any abnormal vibration and noise.

Power operation should be started under no load and at low speed, then the speed is gradually increased until the designed speed is reached.

During power operation, check the noise, increase in temperature and vibration.

If any of the abnormalities listed in Tables 15-5 and 15-6 are found, operation must be

stopped, and inspection for defects immediately conducted.

The bearings should be dismantled if necessary.

Table 15-5 Bearing noises, causes, and countermeasures

Noise types		Causes	Countermeasures
Cyclic	Flaw noise (similar to noise when punching a rivet)	Flaw on raceway Rust on raceway Brinelling on raceway	Improve mounting procedure, cleaning method and rust preventive method. Replace bearing.
	Brinelling noise (Unclear siren-like noise)		
	Flaking noise (similar to a large hammering noise)	Flaking on raceway	Replace bearing.
Not cyclic	Dirt noise (an irregular sandy noise.)	Insertion of foreign matter	Improve cleaning method, sealing device. Use clean lubricant. Replace bearing.
	Fitting noise (drumming or hammering noise)	Improper fitting or excessive bearing clearance	Review fitting and clearance conditions. Provide preload. Improve mounting accuracy.
	Flaw noise, rust noise, flaking noise	Flaws, rust and flaking on rolling elements	Replace bearing.
	Squeak noise (often heard in cylindrical roller bearings with grease lubrication, especially in winter or at low temperatures)	If noise is caused by improper lubrication, a proper lubricant should be selected. In general, however, serious damage will not be caused by an improper lubricant if used continuously.	
Others	Abnormally large metallic sound	Abnormal load Incorrect mounting Insufficient amount of or improper lubricant	Review fitting, clearance. Adjust preload. Improve accuracy in processing and mounting shafts and housings. Improve sealing device. Refill lubricant. Select proper lubricant.

Table 15-6 Causes and countermeasures for abnormal temperature rise

Causes	Countermeasures
Too much lubricant	Reduce lubricant amount. Use grease of lower consistency.
Insufficient lubricant	Refill lubricant.
Improper lubricant	Select proper lubricant.
Abnormal load	Review fitting and clearance conditions and adjust preload.
Improper mounting (excessive friction)	Improve accuracy in processing and mounting shaft and housing. Review fitting. Improve sealing device.

Normally, listening rods are employed for bearing noise inspections.

The instrument detecting abnormalities through sound vibration and the Diagnosis System utilizing acoustic emission for abnormality detection are also applicable.

In general, bearing temperature can be estimated from housing temperature, but the most accurate method is to measure the temperature of outer rings directly via lubrication holes.

Normally, bearing temperature begins to rise gradually when operation is just starting; and, unless the bearing has some abnormality, the temperature stabilizes within one or two hours.

Therefore, a rapid rise in temperature or unusually high temperature indicates some abnormality.

15-5 Bearing dismounting

After dismounting bearings, handling of the bearings and the various methods available for this should be considered.

If the bearing is to be disposed of, any simple method such as torch cutting can be employed. If the bearing is to be reused or checked for the causes of its failure, the same amount of care as in mounting should be taken in dismounting so as not to damage the bearing and other parts.

Since bearings with interference fits are easily damaged during dismounting, measures to prevent damage during dismounting must be incorporated into the design.

It is recommended that dismounting devices be designed and manufactured, if necessary.

It is useful for discovering the causes of failures when the conditions of bearings, including mounting direction and location, are recorded prior to dismounting.

Dismounting method

Tables 15-7 to 15-9 describe dismounting methods for interference fit bearings intended for reuse or for failure analysis.

The force necessary to remove bearings can be calculated using the equations given on page A 142.

Table 15-7 Dismounting of cylindrical bore bearings

Inner ring dismounting methods	Descriptions
 <p>(a) Dismounting by use of a press</p>	<ul style="list-style-type: none"> • Non-separable bearings should be treated carefully during dismounting so as to minimize external force, which affects their rolling elements. • The easiest way to remove bearings is by using a press as shown in Fig. (a). It is recommended that the fixture be prepared so that the inner ring can receive the removal force. • Figs. (b) and (c) show a dismounting method in which special tools are employed. In both cases, the jaws of the tool should firmly hold the side of the inner ring. • Fig. (d) shows an example of removal by use of an induction heater : this method can be adapted to both mounting and dismounting of the inner rings of NU and NJ type cylindrical roller bearings. The heater can be used for heating and expanding inner rings in a short time.
 <p>(b) Dismounting by use of special tools</p>	
 <p>(c) Dismounting by use of special tools</p>	
 <p>(d) Dismounting using induction heater</p>	

Table 15-8 Dismounting tapered bore bearings

Inner ring dismounting methods	Descriptions
 <p>(a) Dismounting by use of a wedge</p>	<ul style="list-style-type: none"> • Fig. (a) shows the dismounting of an inner ring by means of driving wedges into notches at the back of the labyrinth. Fig. (b) shows dismounting by means of feeding high pressure oil to the fitting surfaces. In both cases, it is recommended that a stopper (ex. shaft nuts) be provided to prevent bearings from suddenly dropping out. • For bearings with an adapter sleeve, the following two methods are suitable. As shown in Fig. (c), fix bearings with clamps, loosen locknuts, then hammer off the adapter sleeve. This method is mainly used for small size bearings. Fig. (d) shows the method using hydraulic nuts. • Small size bearings with withdrawal sleeves can be removed by tightening locknuts as shown in Fig. (e). For large size bearings, provide several bolt holes on locknuts as shown in Fig. (f), and tighten bolts. The bearings can then be removed as easily as small size bearings. • Fig. (g) shows the method using hydraulic nuts.
 <p>(b) Dismounting by use of oil pressure</p>	
 <p>(c) Dismounting by use of clamps</p>	
 <p>(d) Dismounting by use of hydraulic nuts</p>	
 <p>(e) Dismounting by use of locknuts</p>	
 <p>(f) Dismounting by use of bolts</p>	
 <p>(g) Dismounting by use of hydraulic nuts</p>	

Table 15-9 Dismounting of outer rings

Outer ring dismounting methods	Description
 <p>(a) Notches for dismounting</p>	<ul style="list-style-type: none"> • To dismount outer rings with interference fits, it is recommended that notches or bolt holes be provided on the shoulder of the housings.
 <p>(b) Bolt holes and bolts for dismounting</p>	

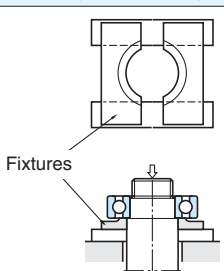
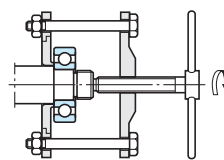
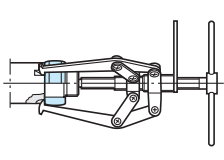
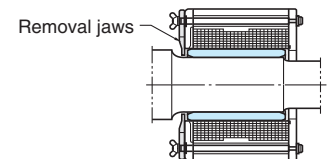
15-6 Maintenance and inspection of bearings

Periodic and thorough maintenance and inspection are indispensable to drawing full performance from bearings and lengthening their useful life.

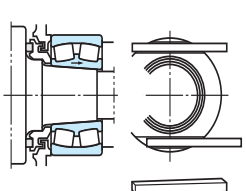
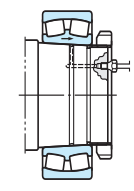
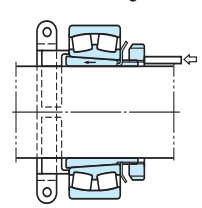
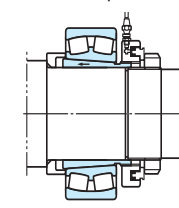
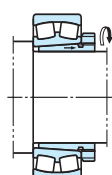
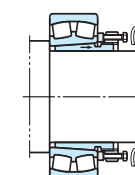
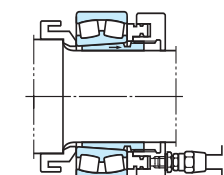
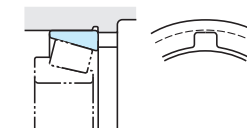
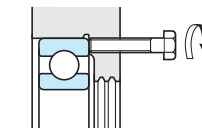
Besides, prevention of accidents and down time by early detection of failures through maintenance and inspection greatly contributes to the enhancement of productivity and profitability.

15-6-1 Cleaning

Before dismantling a bearing for inspection, record the physical condition of the bearing, including taking photographs.

Cleaning should be done after checking the amount of remaining lubricant and collecting lubricant as a sample for examination.

- A dirty bearing should be cleaned using two cleaning processes, such as rough cleaning and finish cleaning.
It is recommended that a net be set on the bottom of cleaning containers.
- In rough cleaning, use brushes to remove grease and dirt. Bearings should be handled carefully. Note that raceway surfaces may be damaged by foreign matter, if bearings are rotated in cleaning oil.
- During finish cleaning, clean bearings carefully by rotating them slowly in cleaning oil.

In general, neutral water-free light oil or kerosene is used to clean bearings, a warm alkali solution can also be used if necessary. In any case, it is essential to keep oil clean by filtering it prior to cleaning.

Apply anti-corrosion oil or rust preventive grease on bearings immediately after cleaning.

15-6-2 Inspection and analysis

Before determining that dismantled bearings will be reused, the accuracy of their dimensions and running, internal clearance, fitting surfaces, raceways, rolling contact surfaces, cages and seals must be carefully examined, so as to confirm that no abnormality is present.

It is desirable for skilled persons who have sufficient knowledge of bearings to make decisions on the reuse of bearings.

Criteria for reuse differs according to the performance and importance of machines and inspection frequency.

If the following defects are found, replace the bearing with a new one.

- Cracks and chips in bearing components
- Flaking on the raceway surfaces and the rolling contact surfaces
- Other failures of a serious degree described in the following section "16. Examples of bearing failures."

15-7 Methods of analyzing bearing failures

It is important for enhancing productivity and profitability, as well as for accident prevention that abnormalities in bearings are detected during operation.

Representative detection methods are described in the following section.

1) Noise checking

Since the detection of abnormalities in bearings from noises requires ample experience, sufficient training must be given to inspectors. Given this, it is recommended that specific persons be assigned to this work in order to gain this experience.

Attaching hearing aids or listening rods on housings is effective for detecting bearing noise.

2) Checking of operating temperature

Since this method utilizes change in operating temperature, its application is limited to relatively stable operations.

For detection, operating temperatures must be continuously recorded.

If abnormalities occur in bearings, operating temperature not only increase but also change irregularly.

It is recommended that this method be employed together with noise checking.

3) Lubricant checking

This method detects abnormalities from the foreign matter, including dirt and metallic powder, in lubricants collected as samples.

This method is recommended for inspection of bearings which cannot be checked by close visual inspection, and large size bearings.

16. Examples of bearing failures

Table 16-1 (1) Bearing failures, causes and countermeasures













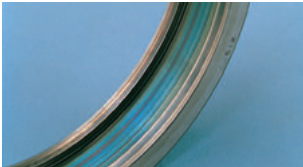

Failures	Characteristics	Damages	Causes	Countermeasures
1 Flaking	 (A-6961)  (A-6476) <p>Flaking is a phenomenon when material is removed in flakes from a surface layer of the bearing raceways or rolling elements due to rolling fatigue.</p> <p>This phenomenon is generally attributed to the approaching end of bearing service life. However, if flaking occurs at early stages of bearing service life, it is necessary to determine causes and adopt countermeasures.</p> <p>[Reference] Pitting Pitting is another type of failure caused by rolling fatigue, in which minute holes of approx. 0.1 mm in depth are generated on the raceway surface.</p>	Flaking occurring at an incipient stage	<ul style="list-style-type: none"> Too small internal clearance Improper or insufficient lubricant Too much load Rust 	<ul style="list-style-type: none"> Provide proper internal clearance. Select proper lubricating method or lubricant.
		Flaking on one side of radial bearing raceway	<ul style="list-style-type: none"> Extraordinarily large axial load 	<ul style="list-style-type: none"> Fitting between outer ring on the free side and housing should be changed to clearance fit.
		Symmetrical flaking along circumference of raceway	<ul style="list-style-type: none"> Inaccurate housing roundness 	<ul style="list-style-type: none"> Correct processing accuracy of housing bore. (Especially for split housings, care should be taken to ensure processing accuracy.)
		Slanted flaking on the radial ball bearing raceway	<ul style="list-style-type: none"> Improper mounting Shaft deflection Inaccuracy of the shaft and housing 	<ul style="list-style-type: none"> Correct centering. Widen bearing internal clearance. Correct squareness of shaft or housing shoulder.
		Flaking occurring near the edge of the raceway or rolling contact surface of roller bearings	<ul style="list-style-type: none"> Heavy impact load during mounting A flaw of cylindrical roller bearings or tapered roller bearings caused when they are mounted. Rust gathered while out of operation 	<ul style="list-style-type: none"> Improve mounting procedure. Provide rust prevention treatment before long cessation of operation.
2 Cracking, chipping	 (A-6395)	Cracking in outer ring or inner ring	<ul style="list-style-type: none"> Excessive interference Excessive fillet on shaft or housing Heavy impact load Advanced flaking or seizure 	<ul style="list-style-type: none"> Select proper fit. Adjust fillet on the shaft or in the housing to smaller than that of the bearing chamfer dimension. Re-examine load conditions.
		Cracking on rolling elements	<ul style="list-style-type: none"> Heavy impact load Advanced flaking 	<ul style="list-style-type: none"> Improve mounting and handling procedure. Re-examine load conditions.
		Cracking on the rib	<ul style="list-style-type: none"> Impact on rib during mounting Excessive axial impact load 	<ul style="list-style-type: none"> Improve mounting procedure. Re-examine load conditions.
3 Brinelling, nicks	 (A-6617) (Brinelling)	Brinelling on the raceway or rolling contact surface	<ul style="list-style-type: none"> Entry of foreign matter 	<ul style="list-style-type: none"> Clean bearing and its peripheral parts. Improve sealing devices.
		Brinelling on the raceway surface at the same interval as the rolling element spacing	<ul style="list-style-type: none"> Impact load during mounting Excessive load applied while bearing is stationary 	<ul style="list-style-type: none"> Improve mounting procedure. Improve machine handling.
		Nicks on the raceway or rolling contact surface	<ul style="list-style-type: none"> Careless handling 	<ul style="list-style-type: none"> Improve mounting and handling procedure.

Table 16-1 (2) Bearing failures, causes and countermeasures

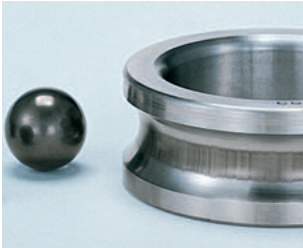
Failures	Characteristics	Damages	Causes	Countermeasures	
4 Pear skin, discoloration	 <p>(A-6720) (Discoloration)</p>	<ul style="list-style-type: none"> · Pear skin is a phenomenon in which minute brinell marks cover the entire rolling surface, caused by the insertion of foreign matter. This is characterized by loss of luster and a rolling surface that is rough in appearance. · In extreme cases, this is accompanied by discoloration due to heat generation. · Discoloration is a phenomenon in which the surface color changes because of staining or heat generation during rotation. · Color change caused by rust and corrosion is generally separate from this phenomenon. 	<ul style="list-style-type: none"> · Entry of minute foreign matter 	<ul style="list-style-type: none"> · Clean the bearing and its peripheral parts. · Improve sealing device. 	
			<ul style="list-style-type: none"> · Too small bearing internal clearance · Improper or insufficient lubricant · Quality deterioration of lubricant due to aging, etc. 		<ul style="list-style-type: none"> · Provide proper internal clearance. · Select proper lubricating method or lubricant.
5 Scratches, scuffing	 <p>(A-6459) (Scuffing)</p>	<ul style="list-style-type: none"> · Scratches are relatively shallow marks generated by sliding contact, in the same direction as the sliding. This is not accompanied by apparent melting of material. · Scuffing refers to marks, the surface of which are partially melted due to higher contact pressure and therefore a greater heat effect. · Generally, scuffing may be regarded as a serious case of scratches. 	<ul style="list-style-type: none"> · Insufficient lubricant at initial operation · Careless handling 	<ul style="list-style-type: none"> · Apply lubricant to the raceway and rolling contact surface when mounting. · Improve mounting procedure. 	
			<ul style="list-style-type: none"> · Improper or insufficient lubricant · Improper mounting · Excessive axial load 		<ul style="list-style-type: none"> · Select proper lubricating method or lubricant. · Correct centering of axial direction.
6 Smearing	 <p>(A-6640)</p>	<ul style="list-style-type: none"> · Smearing is a phenomenon in which a cluster of minute seizures cover the rolling contact surface. · Since smearing is caused by high temperature due to friction, the surface of the material usually melts partially; and, the smeared surfaces appear very rough in many cases. 	<ul style="list-style-type: none"> · Smearing on raceway or rolling contact surface 	<ul style="list-style-type: none"> · Improper or insufficient lubricant · Slipping of the rolling elements <p style="border: 1px solid black; padding: 5px; margin-top: 10px;">This occurs due to the break down of lubricant film when an abnormal self rotation causes slip of the rolling elements on the raceway.</p>	<ul style="list-style-type: none"> · Select proper lubricating method or lubricant. · Provide proper preload.
7 Rust, corrosion	 <p>(A-7130)</p>	<ul style="list-style-type: none"> · Rust is a film of oxides, or hydroxides, or carbonates formed on a metal surface due to chemical reaction. · Corrosion is a phenomenon in which a metal surface is eroded by acid or alkali solutions through chemical reaction (electrochemical reaction such as chemical combination and battery formation); resulting in oxidation or dissolution. It often occurs when sulfur or chloride contained in the lubricant additives is dissolved at high temperature. 	<ul style="list-style-type: none"> · Rust partially or completely covering the bearing surface. 	<ul style="list-style-type: none"> · Improper storage condition · Dew formation in atmosphere 	<ul style="list-style-type: none"> · Improve bearing storage conditions. · Improve sealing devices. · Provide rust preventive treatment before long cessation of operation.
			<ul style="list-style-type: none"> · Rust and corrosion at the same interval as rolling element spacing 	<ul style="list-style-type: none"> · Contamination by water or corrosive matter 	<ul style="list-style-type: none"> · Improve sealing devices.
8 Electric pitting	 <p>(A-6652)</p>	<ul style="list-style-type: none"> · When an electric current passes through a bearing while in operation, it can generate sparks between the raceway and rolling elements through a very thin oil film, resulting in melting of the surface metal in this area. · This phenomenon appears to be pitting at first sight. (The resultant flaw is referred to as a pit.) · When the pit is magnified, it appears as a hole like a crater, indicating that the material melted when it was sparking. · In some cases, the rolling surface becomes corrugated by pitting. 	<ul style="list-style-type: none"> · Pitting or a corrugated surface failure on raceway and rolling contact surface <p style="border: 1px solid black; padding: 5px; margin-top: 10px;">The bearings must be replaced, if the corrugated texture is found by scratching the surface with a fingernail or if pitting can be observed by visual inspection.</p>	<ul style="list-style-type: none"> · Sparks generated when electric current passes through bearings 	<ul style="list-style-type: none"> · Providing a bypass which prevents current from passing through bearings. · Insulation of bearings.

16. Examples of bearing failures

Table 16-1 (3) Bearing failures, causes and countermeasures

Failures	Characteristics		Damages	Causes	Countermeasures
9 Wear	 <p>Normally, wear of bearing is observed on sliding contact surfaces such as roller end faces and rib faces, cage pockets, the guide surface of cages and cage riding lands. Wear is not directly related to material fatigue. Wear caused by foreign matter and corrosion can affect not only sliding surfaces but rolling surfaces.</p> <p>(A-4719)</p>		<p>Wear on the contact surfaces (roller end faces, rib faces, cage pockets)</p> <p>Wear on raceways and rolling contact surfaces</p>	<p>Improper or insufficient lubricant</p> <p>· Entry of foreign matter · Improper or insufficient lubricant</p>	<p>· Select proper lubricating method or lubricant. · Improve sealing device. · Clean the bearing and its peripheral parts.</p>
10 Fretting	 <p>Fretting occurs to bearings which are subject to vibration while in stationary condition or which are exposed to minute vibration. It is characterized by rust-colored wear particles. Since fretting on the raceways often appears similar to brinelling, it is sometimes called "falsebrinelling".</p> <p>(A-6649)</p>		<p>Rust-colored wear particles generated on the fitting surface (fretting corrosion)</p> <p>Brinelling on the raceway surface at the same interval as rolling element spacing (false brinelling)</p>	<p>· Insufficient interference</p> <p>· Vibration and oscillation when bearings are stationary.</p>	<p>· Provide greater interference · Apply lubricant to the fitting surface</p> <p>· Improve fixing method of the shaft and housing. · Provide preload to bearing.</p>
11 Creeping	 <p>Creeping is a phenomenon in which bearing rings move relative to the shaft or housing during operation.</p> <p>(A-6647)</p>		<p>Wear, discoloration and scuffing, caused by slipping on the fitting surfaces</p>	<p>· Insufficient interference · Insufficient tightening of sleeve</p>	<p>· Provide greater interference. · Proper tightening of sleeve.</p>
12 Damage to cages	 <p>Since cages are made of low hardness materials, external pressure and contact with other parts can easily produce flaws and distortion. In some cases, these are aggravated and become chipping and cracks. Large chipping and cracks are often accompanied by deformation, which may reduce the accuracy of the cage itself and may hinder the smooth movement of rolling elements.</p> <p>(A-6455)</p>		<p>Flaws, distortion, chipping, cracking and excessive wear in cages. Loose or damaged rivets.</p>	<p>· Extraordinary vibration, impact, moment · Improper or insufficient lubricant · Improper mounting (misalignment) · Dents made during mounting</p>	<p>· Re-examine load conditions. · Select proper lubricating method or lubricant. · Minimize mounting deviation. · Re-examine cage types. · Improve mounting.</p>
13 Seizure	 <p>A phenomenon caused by abnormal heating in bearings.</p> <p>(A-6679)</p>		<p>Discoloration, distortion and melting together</p>	<p>· Too small internal clearance · Improper or insufficient lubricant · Excessive load · Aggravated by other bearing flaws</p>	<p>· Provide proper internal clearance. · Select proper lubricating method or lubricant. · Re-examine bearing type. · Earlier discovery of bearing flaws.</p>